

**TA0262**

**ARDUINO ROBOT ARM**

**4DOF MECHANICAL**

**CLAW KIT**



## Contents

Chapter 1.	Overview – TA0262.....	1-1
Chapter 2.	Getting started: Arduino Robot Arm 4dof Mechanical Claw Kit .....	1-1
2.1.	What is Arduino? .....	1-1
2.2.	What is IDUINO UNO?.....	1-1
Chapter 3.	Software installation .....	2-2
3.1.	Arduino Software/IDE .....	2-2
3.2.	Play with your first “Hello World” LED example.....	2-3
Chapter 4.	Hardware installation .....	3-5
4.1.	Unboxing and Component list .....	5-5
4.2.	Circuit soldering.....	5-6
Chapter 5.	Software debugging .....	6-8
5.1.	Arduino UNO Code Uploading .....	8-8
5.2.	Servo debugging .....	8-9
5.3.	Power supply.....	9-11
Chapter 6.	System Debugging .....	11-12
6.1.	Rack mounting .....	12-12
6.2.	Rack debugging .....	12-33
6.3.	Overall system debugging.....	33-34
7.	Have fun with your arm robot.....	34-35
7.1.	Manually control .....	35-35
7.2.	PC control interface .....	35-35

## Chapter 1. Overview – TA0262

In this instruction, we will introduce you through the fun project of the Arduino Robot Arm 4DOF Mechanical Claw Kit. This DIY Arduino UNO based Bluetooth robot kit is based on Arduino Uno development board. This very simple and easy to build kit is the perfect Arduino Project for Beginners and is a great learning platform to get into Robotics and Engineering.

The Robot Arm comes flat pack for assembly and requires very minimal soldering to get it up and running. Integrates 4 SG90 servos that allows 4 Degree of motion and can pick up light items with the claw. Arm control can be performed by the 4 potentiometers. Let's get started!

## Chapter 2. Getting started: Arduino Robot Arm 4dof Mechanical Claw Kit

### 2.1. What is Arduino?

Arduino is an open-source electronics platform based on easy-to-use hardware and software. Arduino boards can read inputs - light on a sensor, a finger on a button, or a Twitter message - and turn it into an output - activating a motor, turning on an LED, publishing something online. You can tell your board what to do by sending a set of instructions to the microcontroller on the board. To do so you use the Arduino programming language (based on Wiring), and the Arduino Software (IDE), based on Processing.

### 2.2. What is IDUINO UNO?



The iDuino Uno is on the ATmega328. It has 14 digital input/output pins (of which 6 can be used as PWM outputs), 6 analogue inputs, a 16 MHz ceramic resonator, a USB connection, a power jack, an ICSP header, and a reset button.

It contains everything needed to support the microcontroller; simply connect it to a computer with a USB cable or power it with a AC-to-DC adapter or battery to get started.

## Chapter 3. Software installation

In this section, we will introduce you the development platform where you translate creative mind into codes and let it fly.

### 3.1. Arduino Software/IDE

Download from [here](#). Open Windows-based app by double clicking it and follow the instruction to complete (Remember to install everything driver for Arduino). Easy!

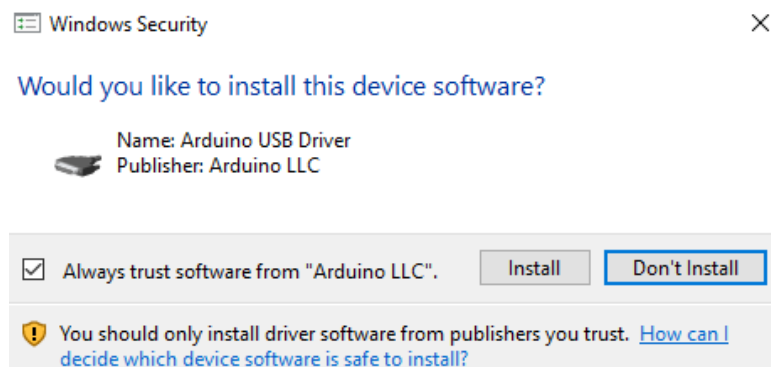

Figure 1 Installation of drivers

Connecting your UNO board with your computer

Connecting UNO and your PC by a blue USB cable, and if connected correctly you will see the green power LED light up and another orange LED is blinking.

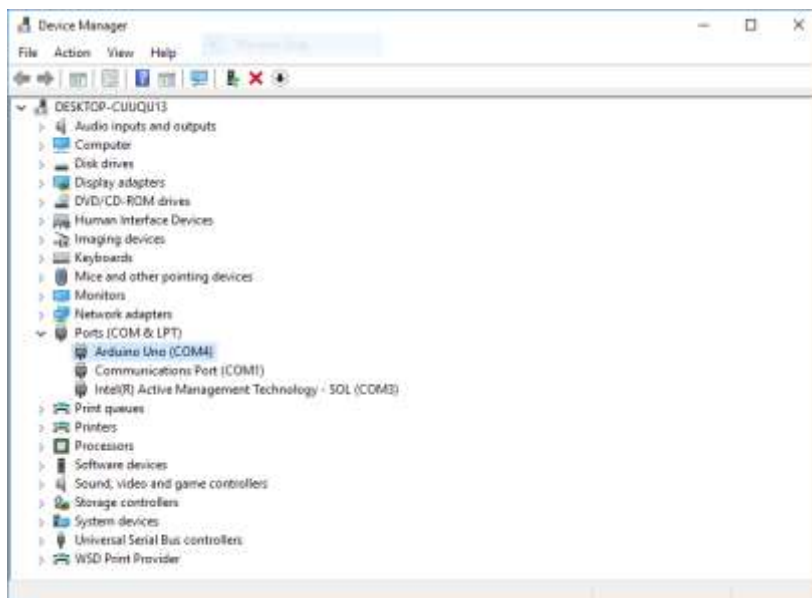

Figure 2 Check Your special COM and note it down the number

Find your Serial COM number and note it down.

We need to figure out which channel COM is currently communicating between PC and UNO. Following the path: Control panel | Hardware and Sound | Devices and Printers | Device Manager | Ports (COM & LPT) | Arduino UNO (COMx)

## Chapter 3 Software installation

Note down the COM number as we require this later. As the COM port may vary from time to time, this step is vital. In this case for demonstration purpose, we are using the COM 4.

### 3.2. Play with your first “Hello World” LED example

Firstly, let’s tell IDE where to find our Arduino port and which board you are currently using: The following instruction (Figure 3 and 4) shows the details:

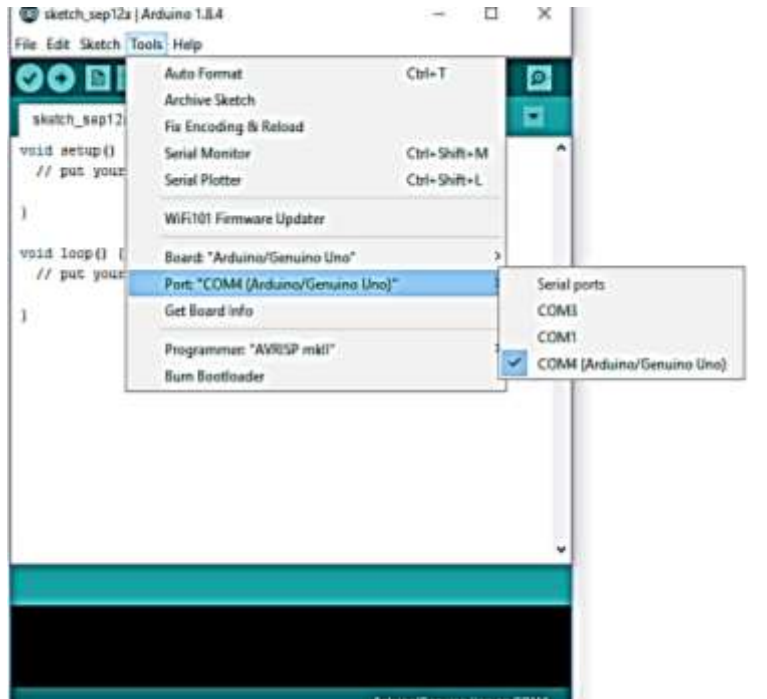

Configuration of Ports



Configuration of the Board



## Chapter 3

### Software installation

It's time to play with you first simple example. Following the path by File | Examples | 01. Basics | Blink. A new code window would pop up, press the arrow symbol to upload. You will notice the orange LED is blinking almost every second.

## Chapter 4. Hardware installation

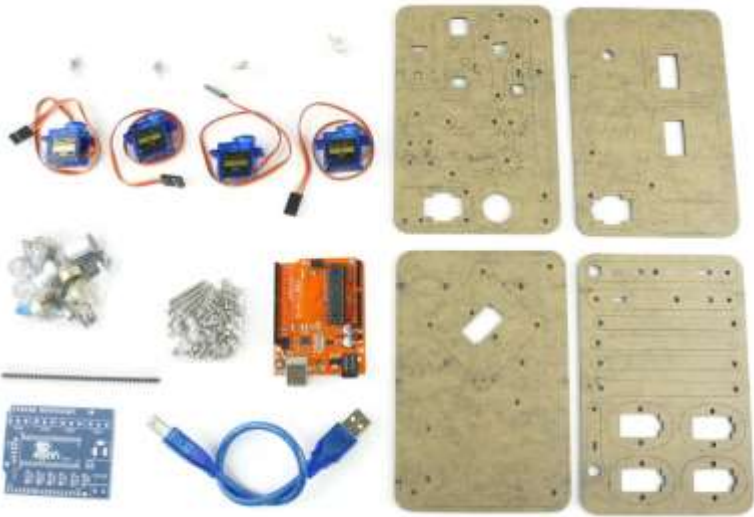
### 4.1. Unboxing and Component list

	<ol style="list-style-type: none"><li>1. 4 x Servo SG90 with servo package (screw and nuts included)</li><li>2. 4 x Base racks with protection cover (easy to remove) and screw package</li><li>3. Robot Arm extension board with separate power jack (Please see power solution)</li><li>4. USB cable</li><li>5. Iduino UNO Board</li></ol>
 <p>M3*30    M3*10    M3*8    M3*6    Tapping Nut Screw</p>	<p>In the rack package, from the left to right:</p> <ol style="list-style-type: none"><li>1. M3 * 30mm</li><li>2. M3 * 10mm</li><li>3. M3 * 8mm</li><li>4. M3 * 6mm</li><li>5. Tapping skew</li><li>6. M3 nut</li></ol>

### 4.2. Circuit soldering

This Robot Arm Kit requires very minimal soldering to get everything working and running. The Robot Arm Extension Board is used to connect interface between controller, in this project, the four potentiometers and Iduino UNO Board.

**Caution:** Please be careful when using hot Soldering Iron.

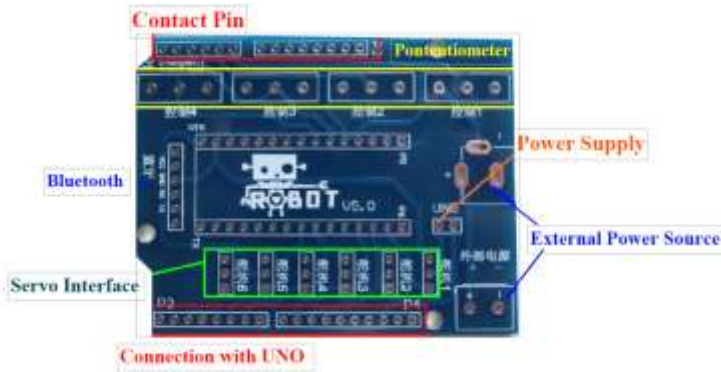
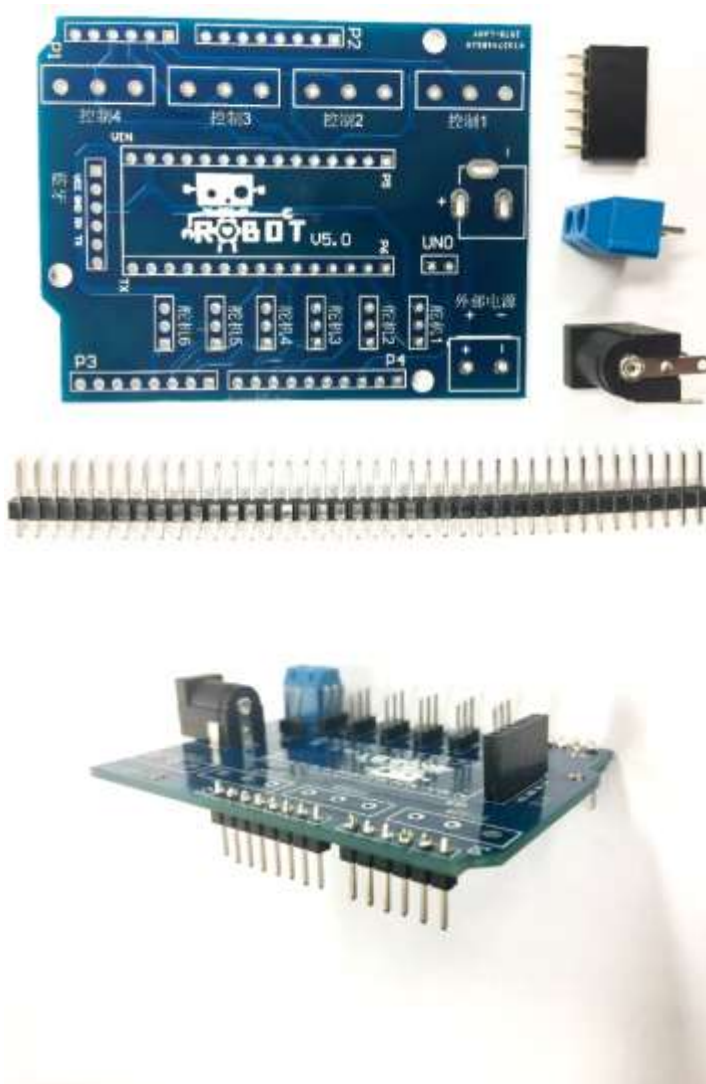

Figure 3 Basic illustration of Robot ARM board



Prepare:

1. One Robot Arm Extension Board
2. One 12V Black Power jack
3. 52P Pin headers
4. One blue External Power supply interface
5. One Black Bluetooth Interface

Then solder Pins for the servos and Power jack.

Please be aware that the Pins for servo interface are facing upwards, for Iduino interface downwards.



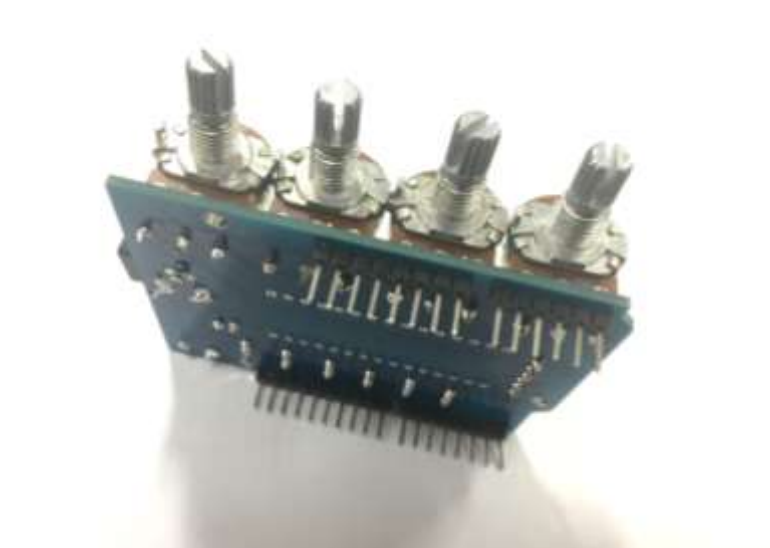

Then solder the four potentiometers

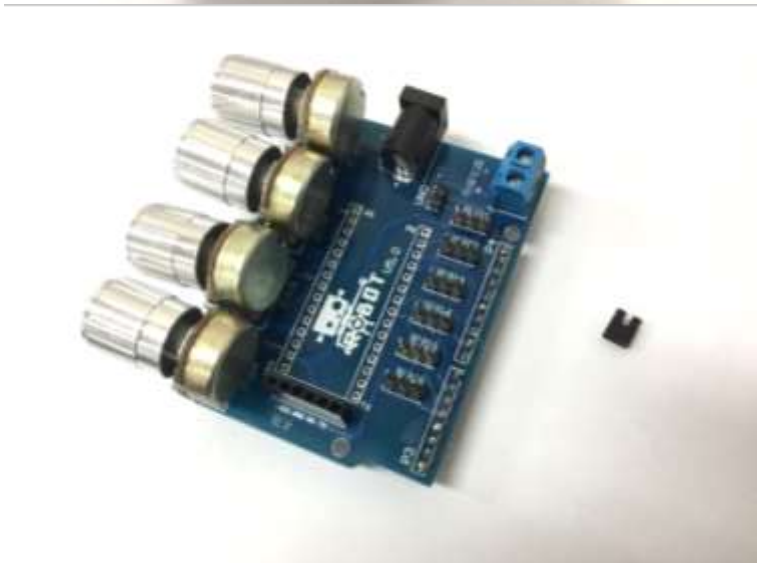

The jumper cap is used for shortcut Robot Arm Extension Board and Iduino UNO Board, which means you do not have to power the Iduino UNO board separately.

Insert in the jumper cap as we are using one external power supply, 12V battery Box.

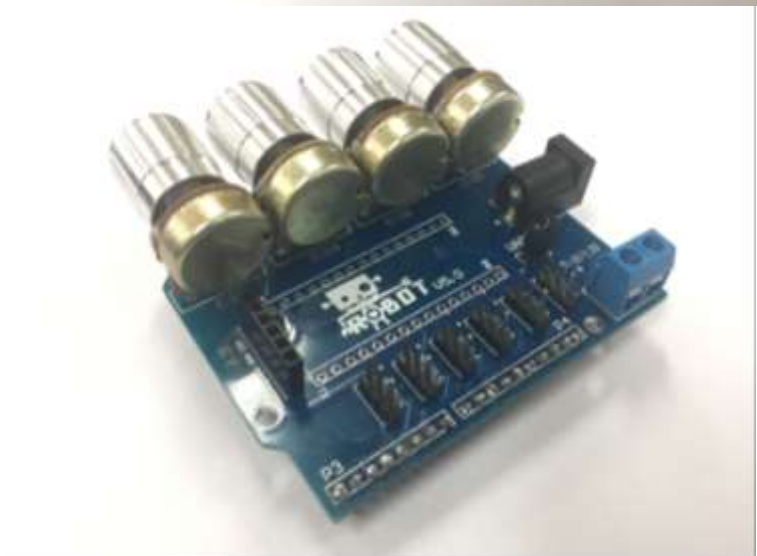

Then put four silver covers on the naked potentiometers.

Now you have completed the soldering part!

## Chapter 5. Software debugging

### 5.1. Arduino UNO Code Uploading

The Robot will perform on how it is programmed. Understanding and absorbing what is inside of Iduino UNO board, i.e. the programming code is a critical part of learning process. In this section, our end goal is to make sure servos and potentiometers are functioning well.

If this is your first Arduino project, please follow the instruction carefully. Firstly, download the related codes from our website.

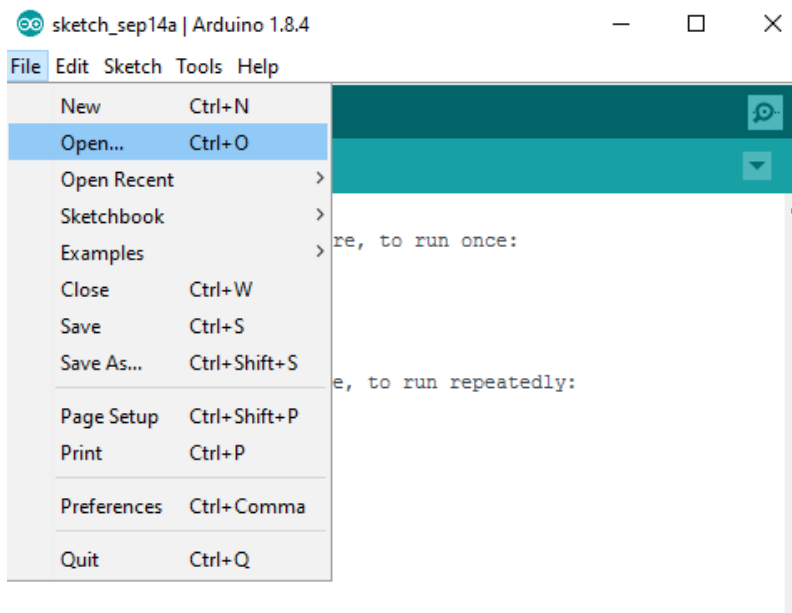

Double click the icon to open the program and open the file in the path: File | Open

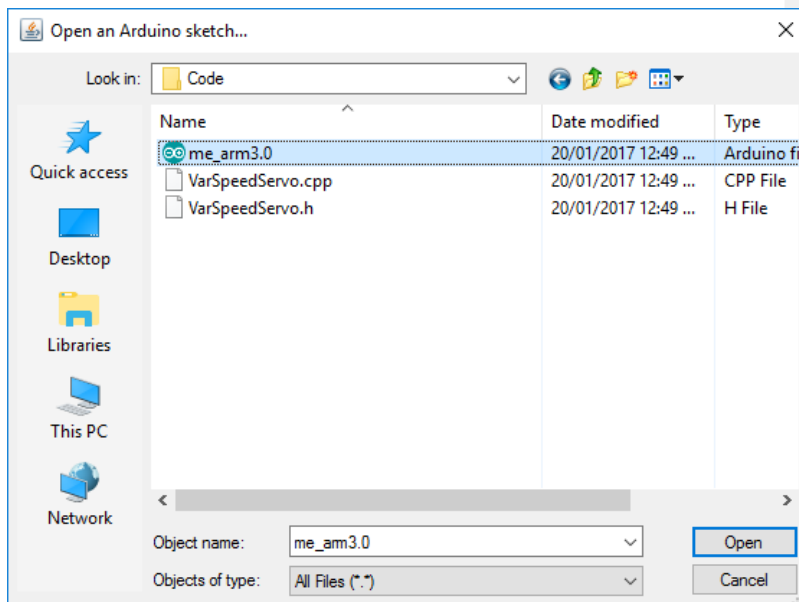

Open the me\_arm3.0 Arduino file

## Chapter 5 Software debugging

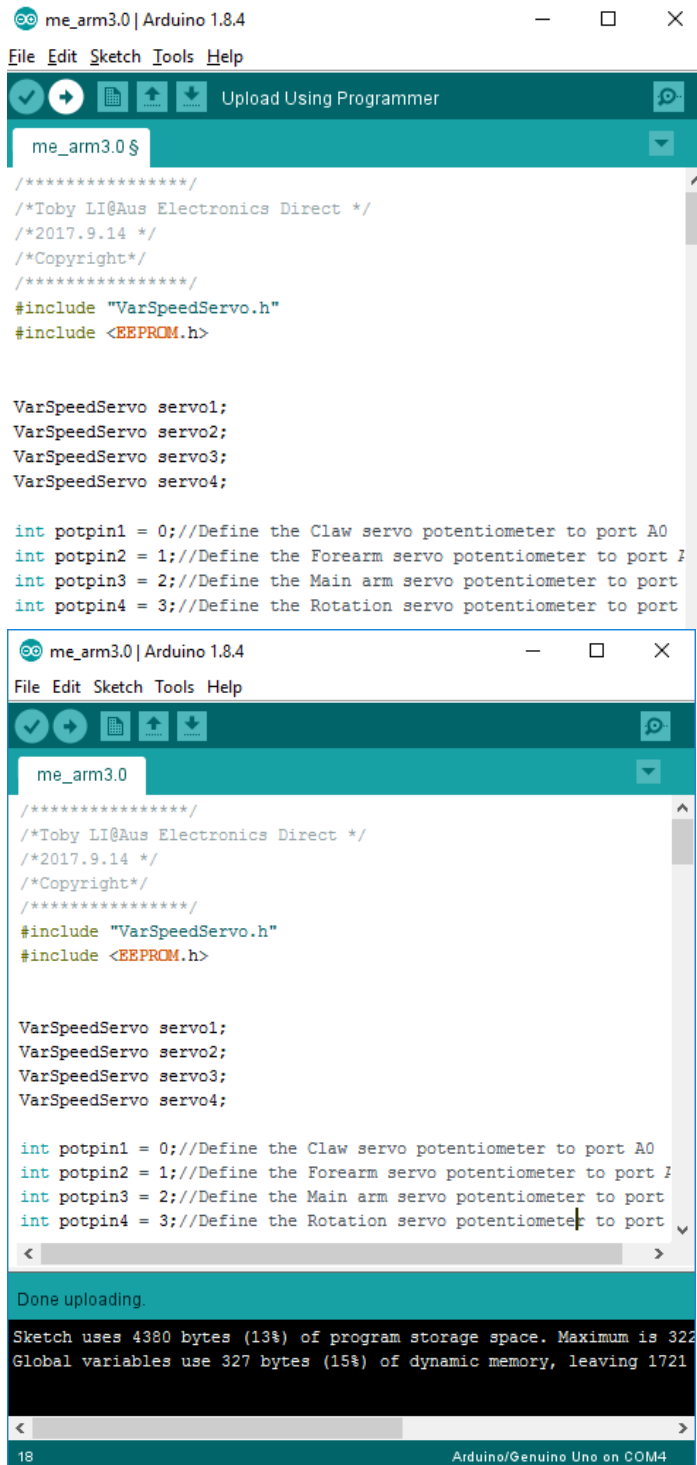

Click the upload button with right arrow on the Tool Bar to upload your file to UNO

Done uploading status, if not, check the Board and Ports in the 3.2 section to make sure you're connecting your UNO correctly

### 5.2. Servo debugging

Then let's test out our servos to see whether they're running smoothly. The servos should rotate smoothly as you play round with corresponding potentiometers. If not, make sure you have uploaded your code correctly with "Done upload" sign described above and insert the servo board firmly onto the UNO board with each of the pins correctly lined up. Most importantly, plug in the reliable power supply correctly where power supply instructions will be illustrated in the next part. Carefully read it otherwise you may burn out your Arduino core microcontroller.

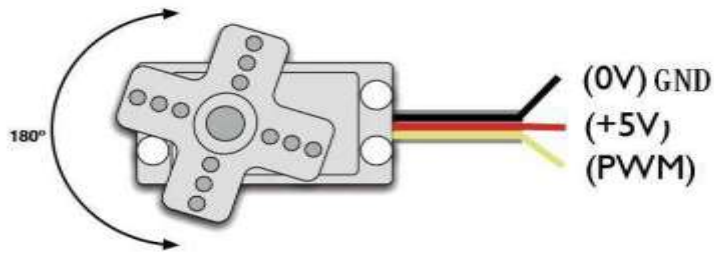

Servo has three pins:

- Signal
- GND
- VCC

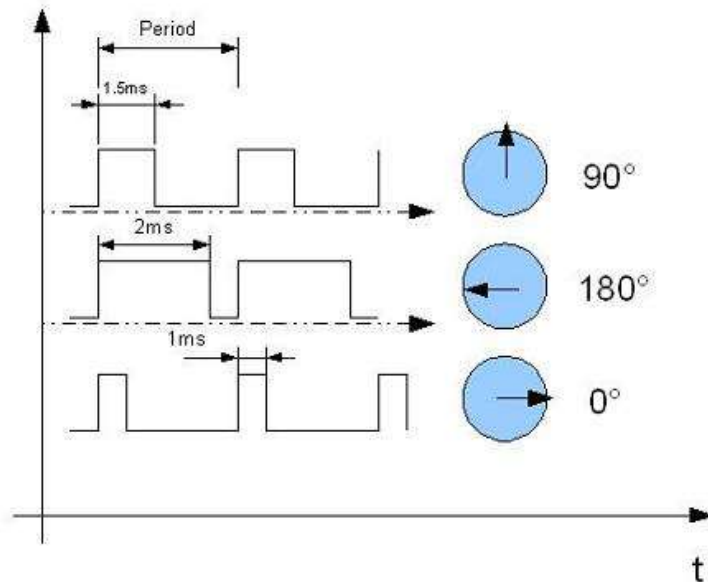

The rotation angle is regulated by PWM (pulse width modulation) signal duty cycle.

The frequency of PWM usually is in range from 30 to 60Hz – this is so called refresh rate. If this refresh rate is too small then the accuracy of servo reduces as it starts losing its position periodically if rate is too high, then servo can start to chatter. It is important to select optimal rate, that servo motor could lock its position.

Please ensure each servo works well as they are hard to remove.

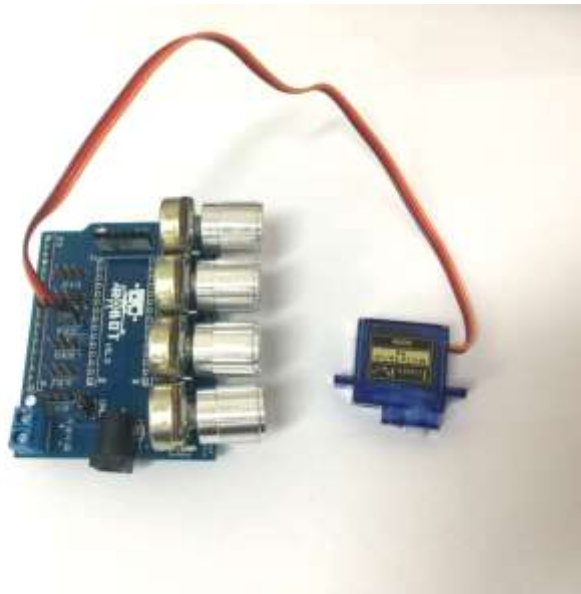

Connect the servo interface to the UNO servo slot one-by-one, from slot 4 to slot 1 which are controlled by the corresponding potentiometer



Plug the 9-12v 2A power supply in the Arduino power jack with jumper cap (the Servo board) on

### 5.3. Power supply

Power plays a vital role in running the Robot Arm system as power supply deficiency can lead to servo steering gear jitter and program would run abnormally. Two independent power supplies will be required, one to drive the Uno development board and another to drive the potentiometer servo controllers. In this section, we introduce you several power supply alternatives for your convenience:

- a) (Recommended) Use a 5V 2A power adaptor and plug into the 2.1mm DC socket on the potentiometer board.
- b) (Alternatively) Use a 5V 2A power supply and terminate into the blue terminal block on the potentiometer board.
- c) (Recommended) Use a 9v to 12v power adaptor for the Arduino UNO development board via the 2.1mm DC socket on the Uno board.
- d) (Alternatively) Use a USB A to B (printer cable) supplied to provide a steady 5V power input into the Uno board from a UB charger, PC or laptop.

**NOTE: When making modifications to the code on the Uno Board, please ensure to remove the Robot Arm Servo Controller board from the Uno development board and disconnect the Uno Board Power supply.** Otherwise, it may cause irreparable damage to your Robot and PC as it may drive a large current through your USB port.

## Chapter 6. System Debugging

### 6.1. Rack mounting

In this section we are guiding you through the Robot Arm Base and rack installation.



Peer off the protection paper of the rack base



Prepare the items:

- Base
- 4 x M3 nuts
- 4 x M3 \* 30 mm screws



Assemble the parts as shown on the left



Prepare the items:

- 4 x M3 nuts
- 4 x M3 \*10mm screws



Fasten the screws and nuts as shown on the left, which are used to secure our Iduino UNO Board



Then prepare the items:

- 2x M3 \*8mm screws
- Black Servo holder
- Black Servo rack



Pull the cable thread through the servo bracket hole as required to connect to Iduino UNO Board in the following steps

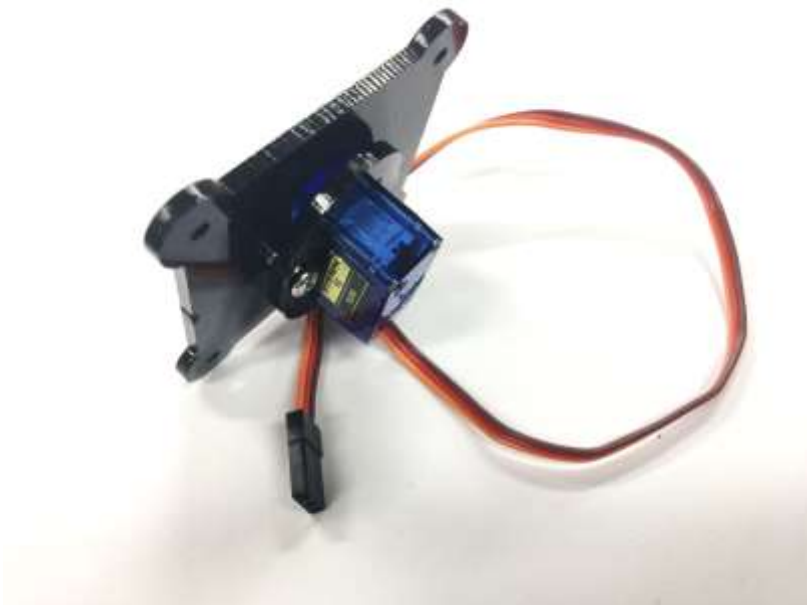

Then insert the Servo bracket holder on the top of servo holder. Now you can see Servo is secured and sandwiched between holder and bracket.



It should look like this



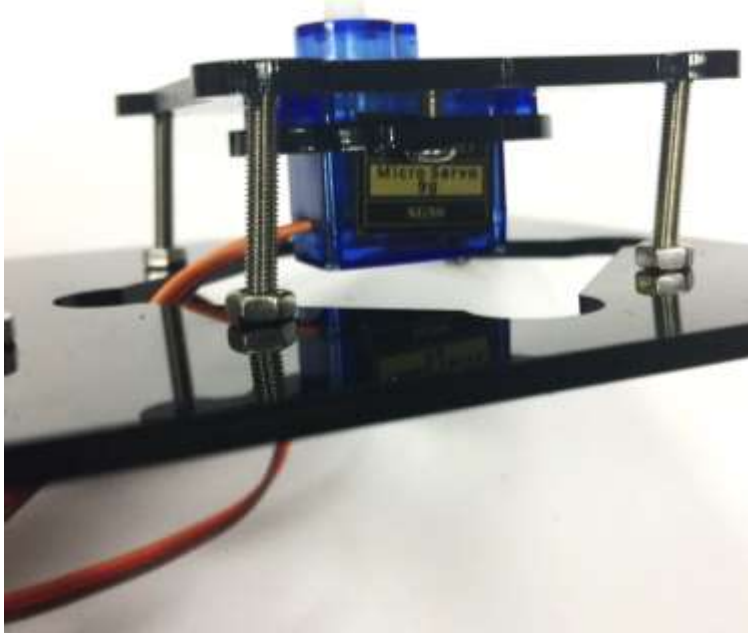

Then secure it as shown on the left



It should look like this



Then prepare items to build  
Forearm of the Robot

1. 2 x M3 \*8mm screws
2. One Servo Bracket
3. One Servo SG90
4. One Black Main Arm Base



Secure the Servo with Bracket and Base in the same way as instructed in the last Servo



Prepare the items:  
1. 1 x M2.5 tapping screw  
2. One Servo Horn



Secure the Horn on the black Main arm acrylic with M2.5 tapping screw

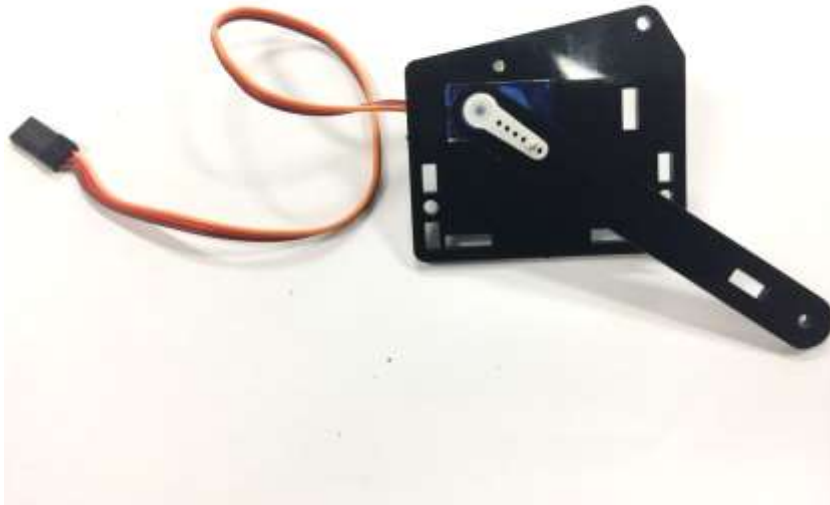

Insert Main Arm onto the Servo and rotate it clockwise until it stops rotating as it is programmed to rotate anticlockwise.



Pull out the Main Arm and put it back horizontally, this step is to ensure Servo will turn anticlockwise from this very point (0 degree) and not break the arm when power turns on to rotate



Gather a self-tapping screw from the rack package and secure it shown on the left



Gather the items:

1. M2.5 Tapping screw
2. Servo horn
3. Black Acrylic Arm Joint



Then secure the horn to the  
Acrylic arm



Then let's build the forearm,

1. 2 x M3 \* 8
2. Self-Tapper Screw  
(From the servo  
package)

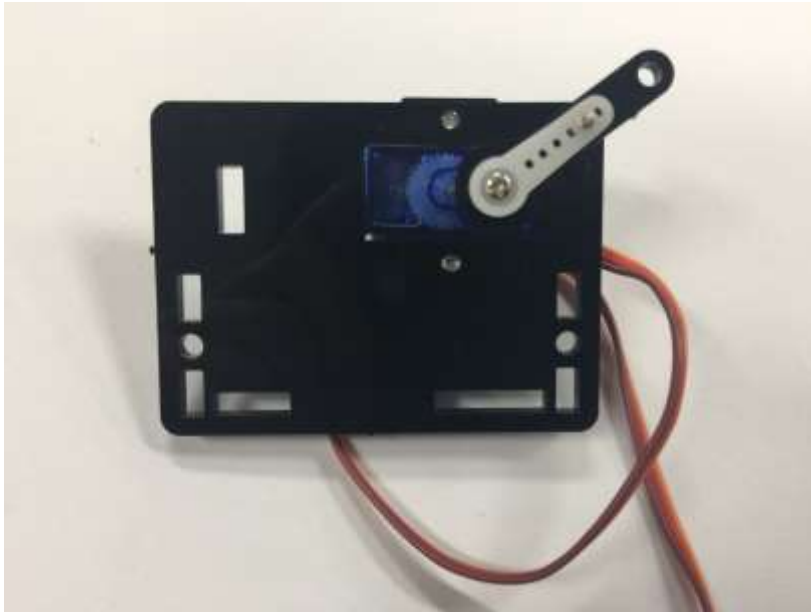

Assemble the servo on the black rack base in the same way as shown in the previous instruction.



- Prepare the items:
1. 2 x tapping screws from the servo package
  2. one M3 \* 8
  3. One Servo Horn

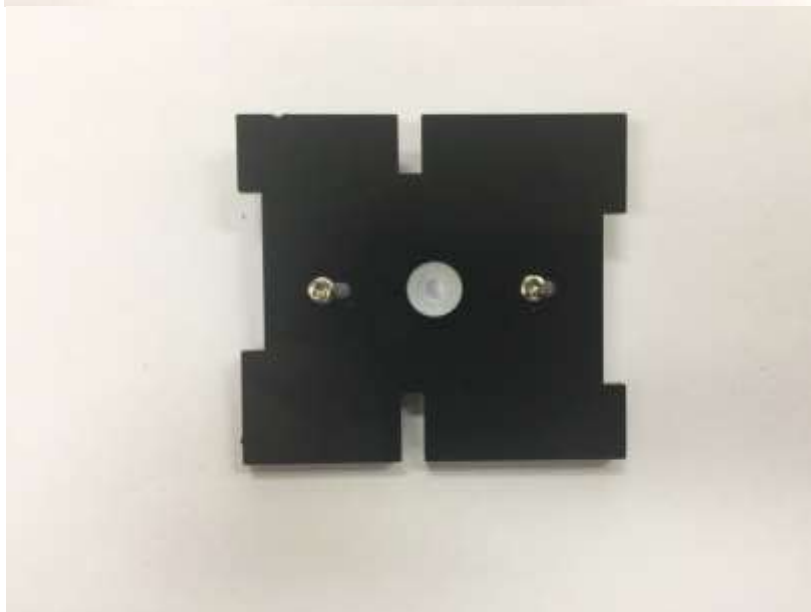

Secure the Servo Horn on the Rack Base



Connect two active joints by screw, remember do not over tighten the screws as they are required to rotate freely

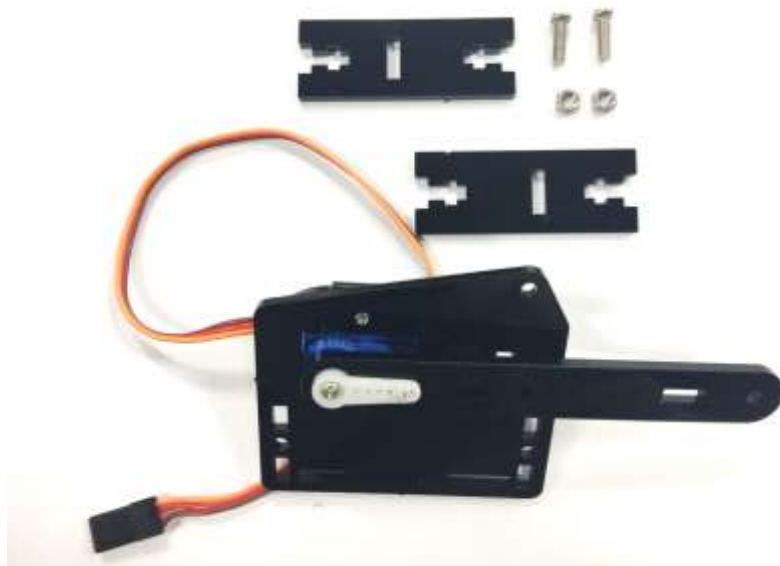

Prepare the items:  
1. 2 x M3\*10mm  
2. M3 nuts  
3. Two black Clapboard Acrylic



Place the two Clapboard Acrylic in the corresponding wing slot

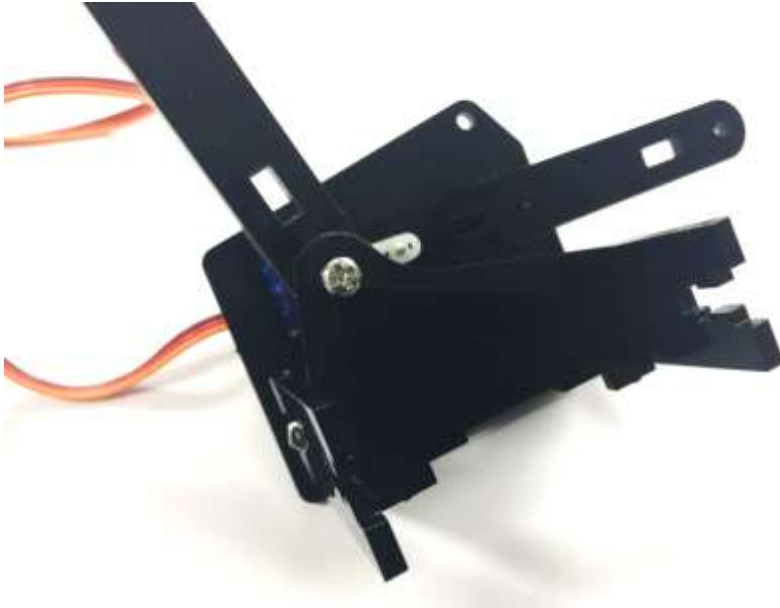

Firstly, insert the Clapboard in the corresponding slots and in the following steps it will be secured with one screw and nut on each side

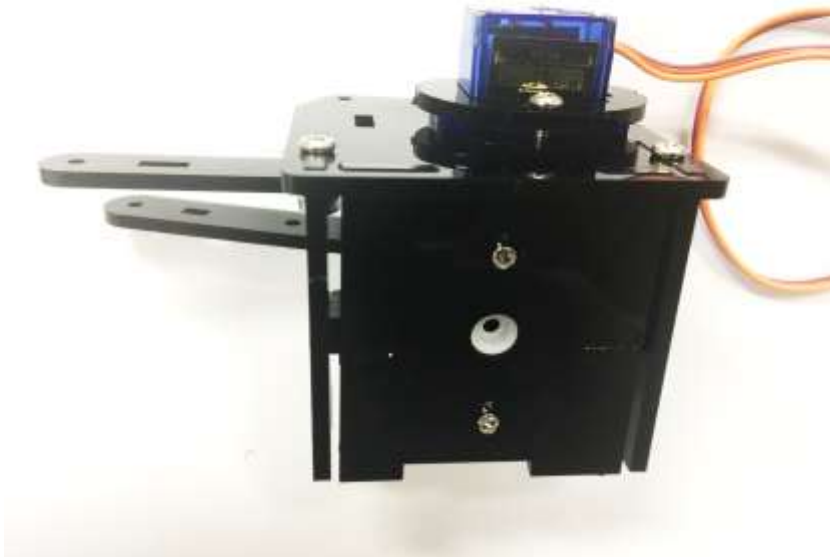

Then insert the rack base in the corresponding slot between two clapboards



It should look like this



Secure the Clapboard on the Main Arm base with one pair of screw and nut.

Tip: Hold the nut in the slot and then screw the M3 in.



Secure the Clapboard on both side as shown on the left



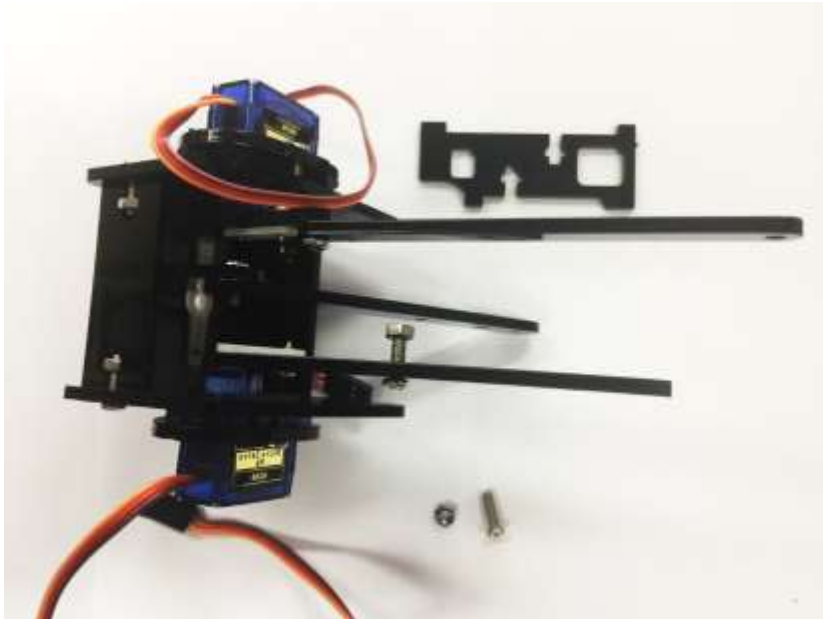

Secure the backbone acrylic between forearm and main arm by:

1. 2 x M3 \* 10mm
2. two nuts

Tip: Hold the nut in the slot and then screw the M3 in.

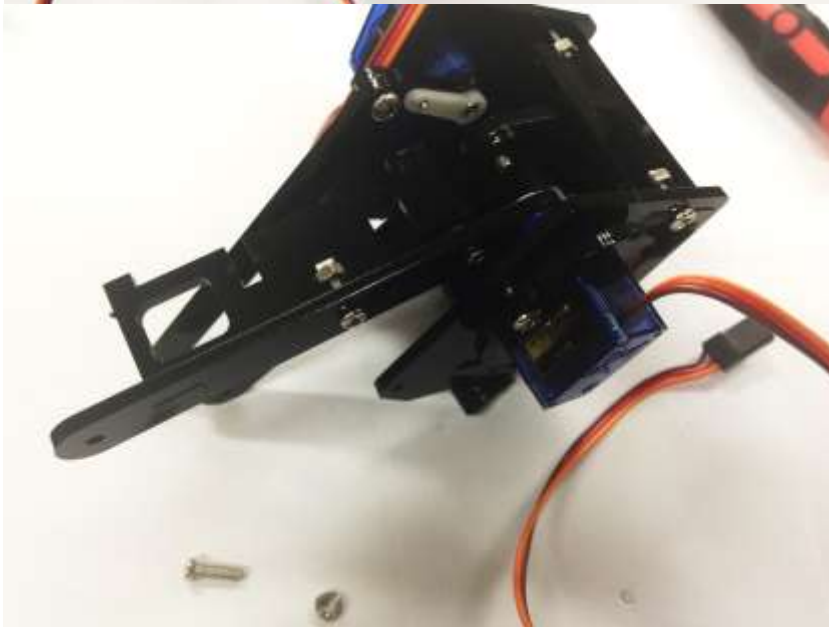

Fix the other side as well



Then prepare M3\*6mm screw and one long arm acrylic

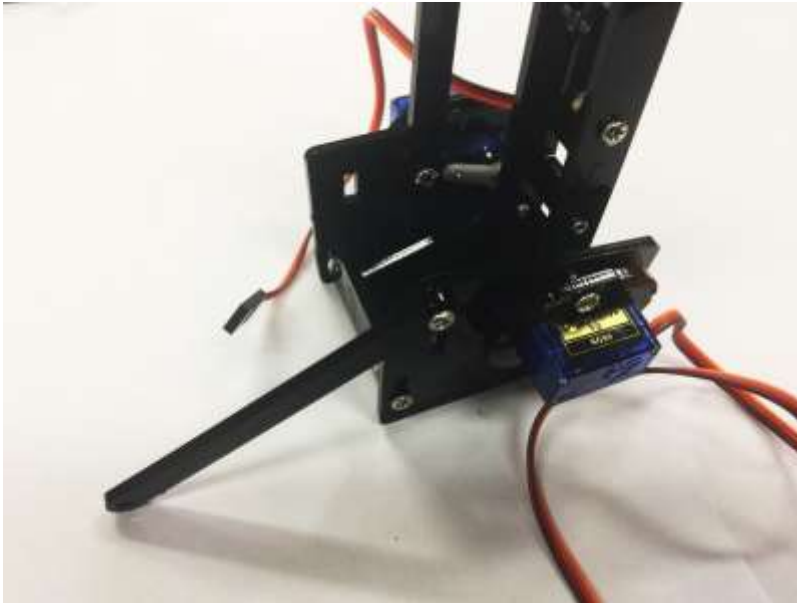

Secure it on the bottom right side

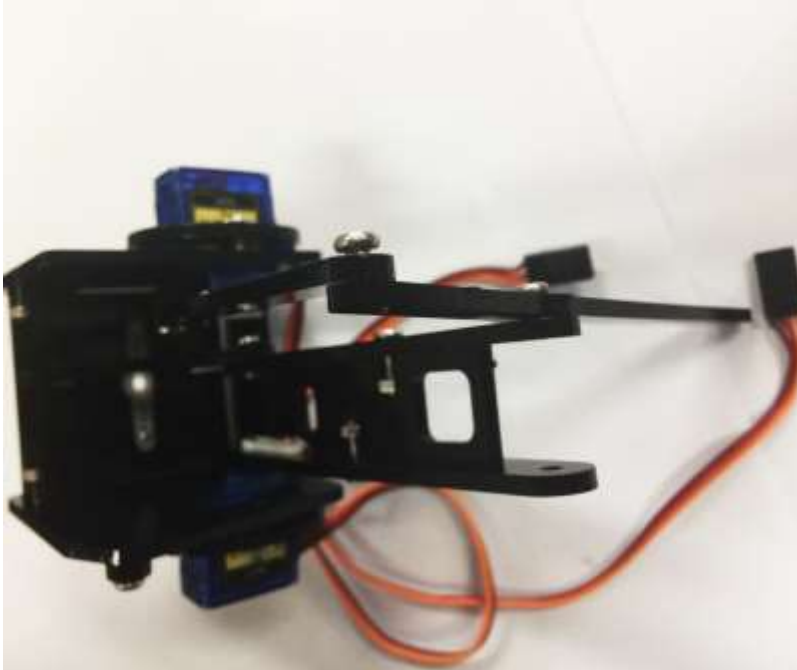

It should look like this

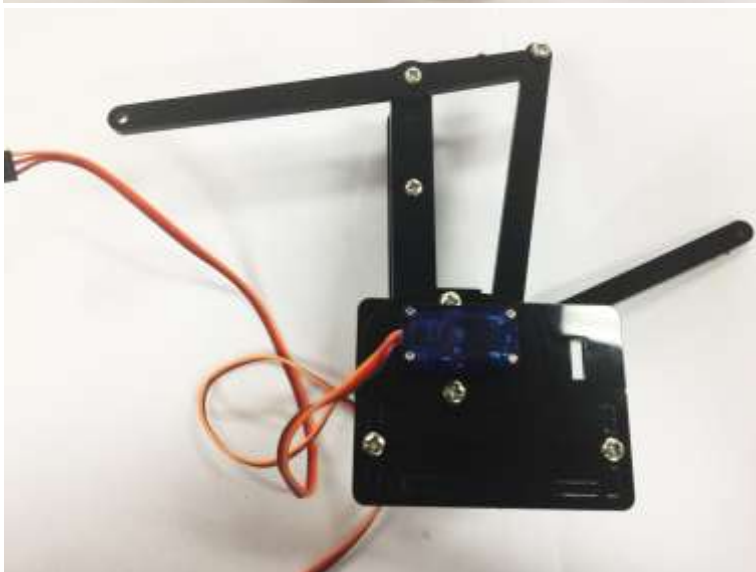

Then use another black long arm with three active joints to connect two forearm joints

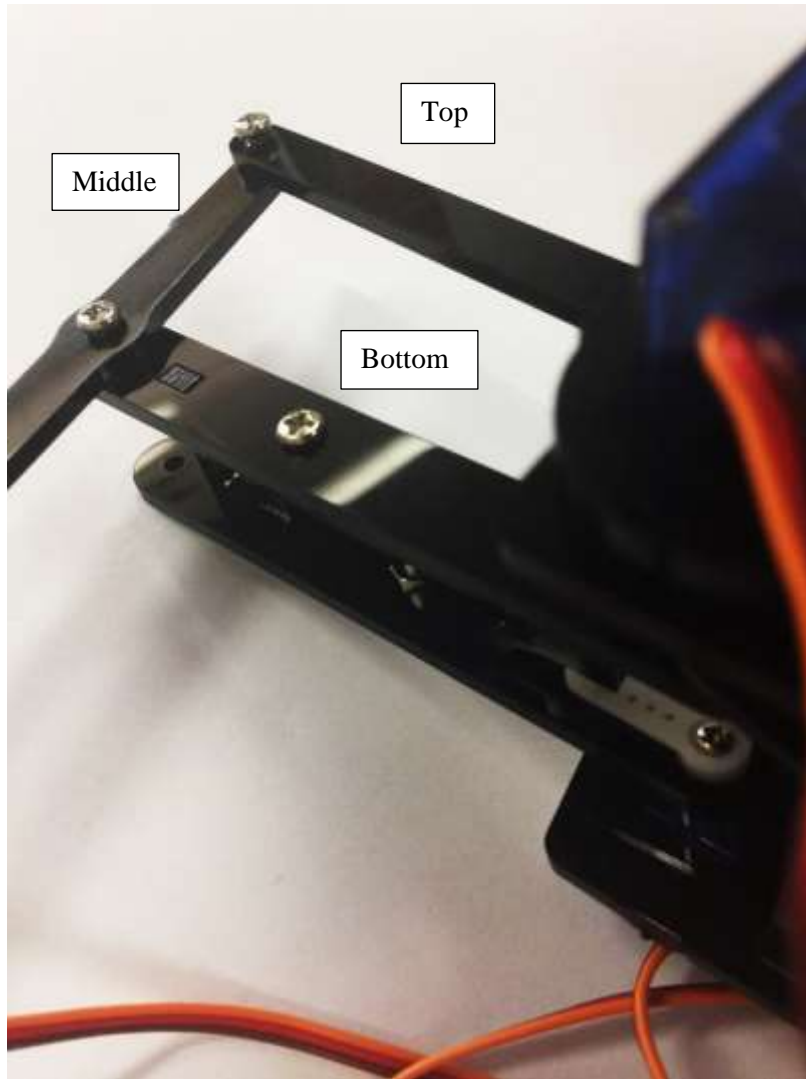

Please secure the screws in the right sequence. Backbone acrylic in the bottom forearm in the middle and the other one lies on the top

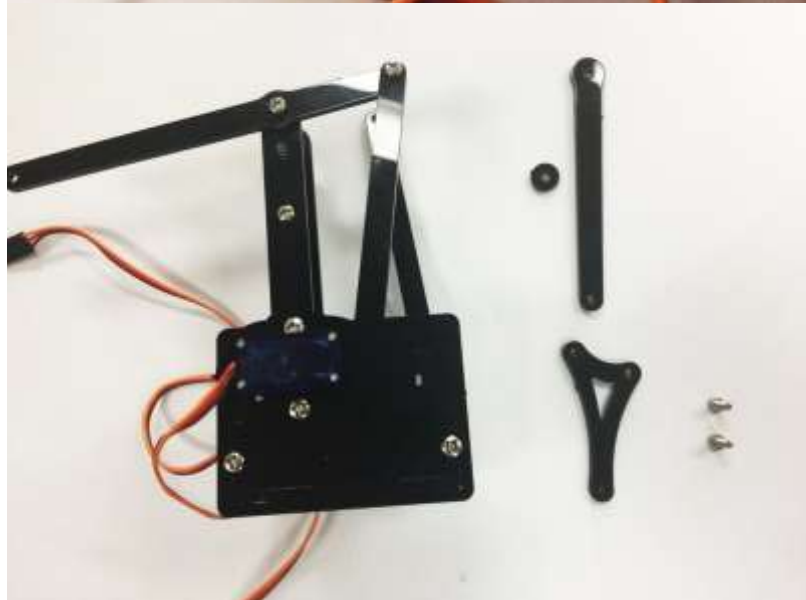

Prepare the items to build right side support arm:

1. Two M3 \* 8
2. One black circular spacer
3. One black Support arm
4. One black triangle support connector



Fix the first screw as shown on the left. The circular spacer lies in the between.

Please do not over tighten the screws as there are active joints as they need to rotate freely without rubbing the adjacent acrylics

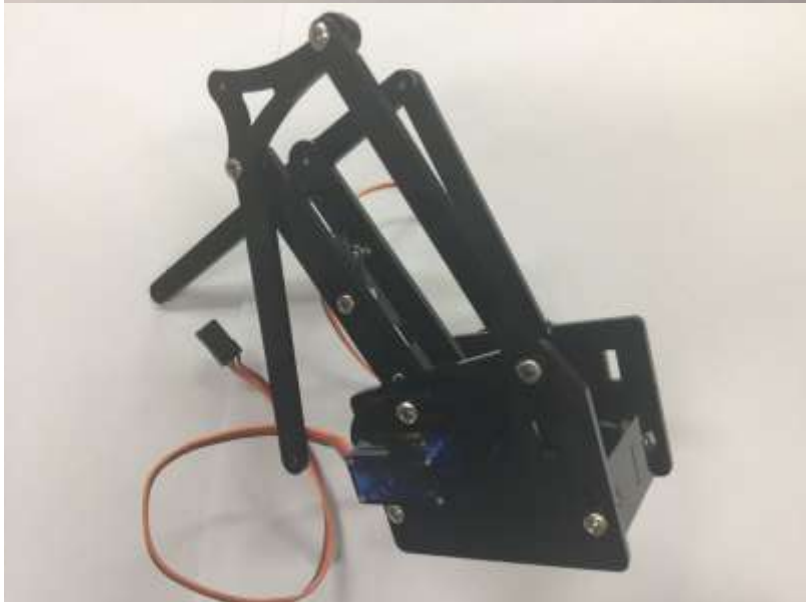

Fix the other end with black support arm.

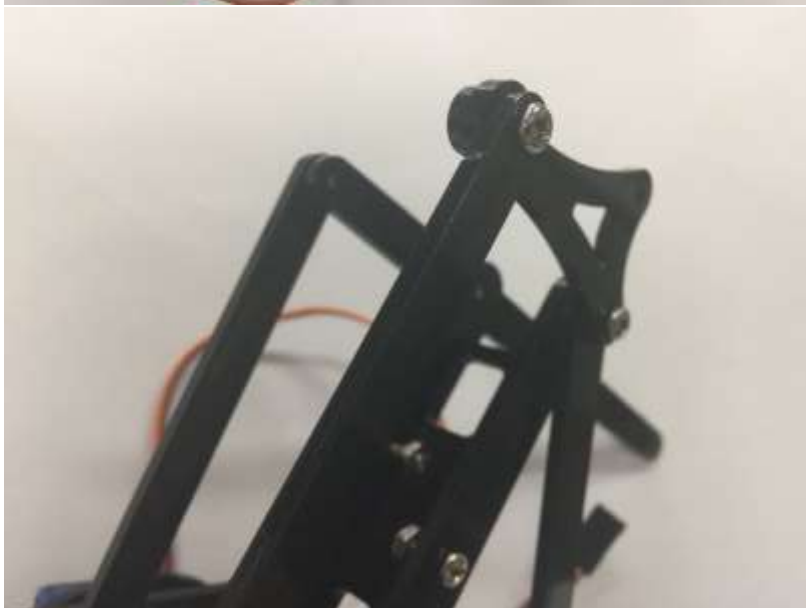

It should look like this. Now the forearm still has three free dangling ends which are eventually connected to secure the claw part.



Prepare the Claw servo parts:

1. Two square servo brackets
2. 4 x M3\* 8mm screws
3. One servo
4. Two connector accessories

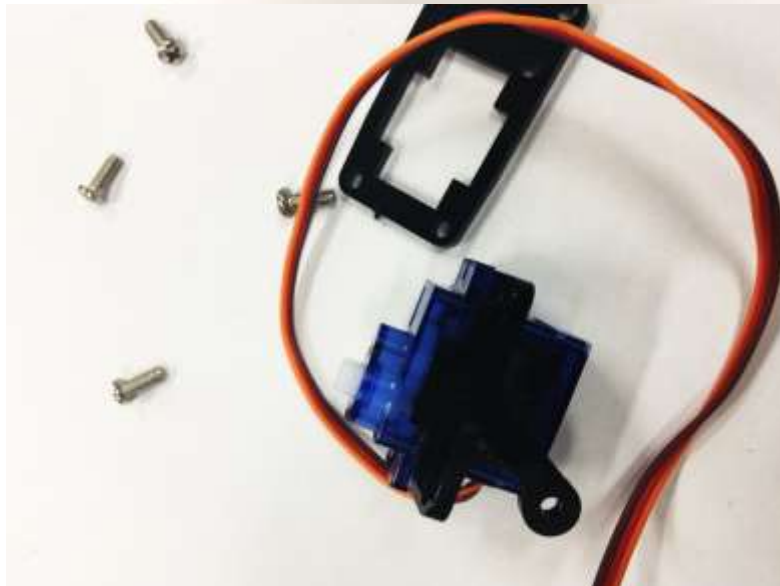

Place the square bracket in the bottom and pull the cables out as required to connect to Robot Extension Board

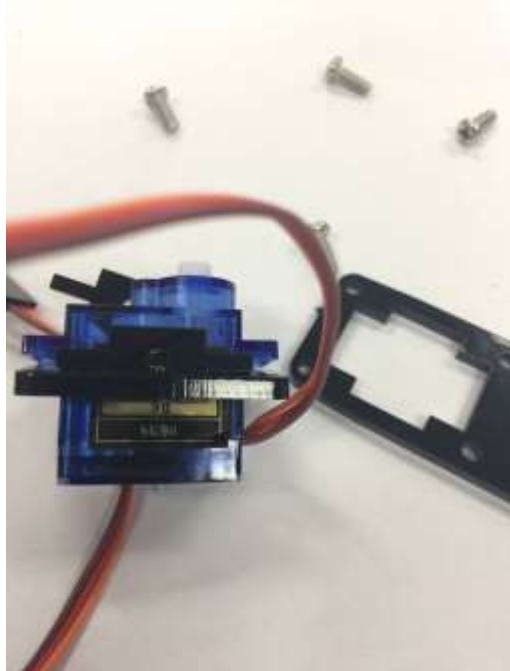

It should look like this



Place the rectangle bracket on the top of the Servo and secure the Servo with four M3\*8mm screws



Fix the two claws on the rectangle servo bracket with two M3\*6mm screws.

Remember to put one black circular spacer in between to reduce friction.



Then gather:

1. 4 x M3 \*8 mm screws
2. One short connector
3. One circular spacer



Secure it on the left-hand side of the claw as shown on the left.

Remember to put the spacer in between



Prepare the following to connect Claw and Triangle support connector:

1. Two M3\*8mm screws
2. One spacer
3. One support arm



Secure the Support arm onto the Triangle connector

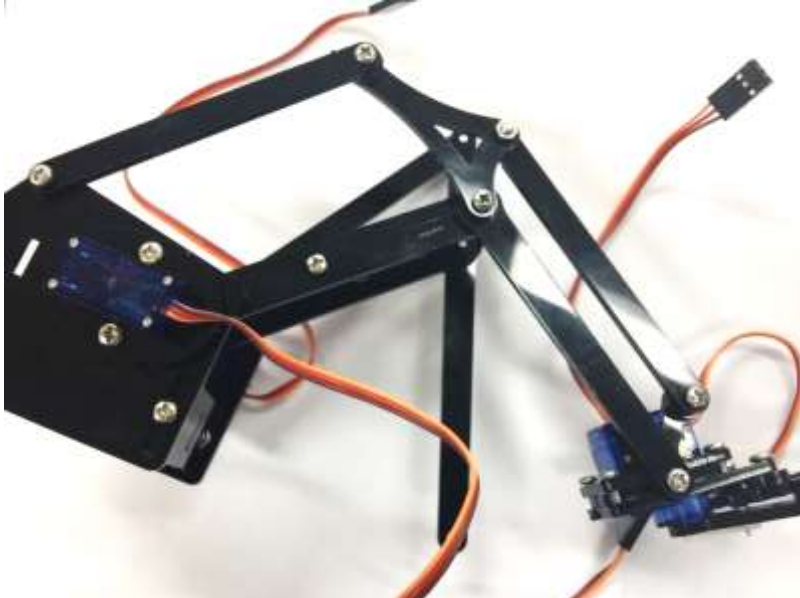

Then the entire Claw part can be secured with the three free dangling Forearm ends.

Please do not tighten the screws for active joints.



Prepare the tapping screw in the Servo package and servo horn.





Secure the horn with tapping screw as shown on the left



Pull the claws widely open and then insert the short arm we created in the last step and screw it firmly.

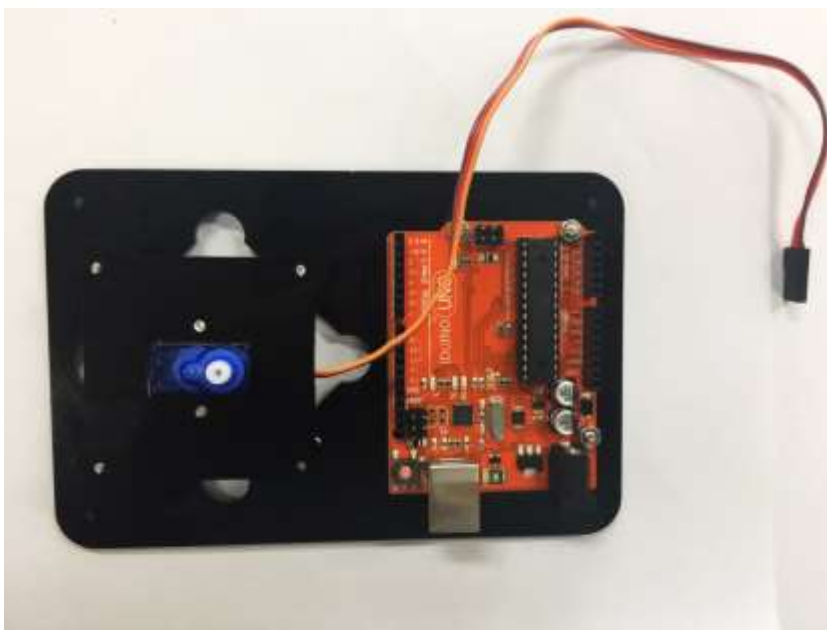

Secure the Arduino UNO Board on the Base

Chapter 6  
System Debugging

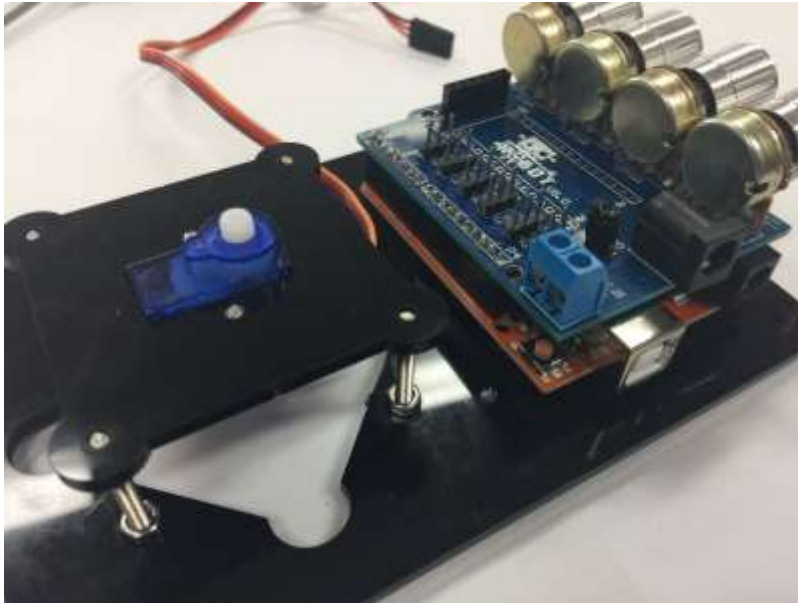

Place the Robot Arm Extension Board on the top of the Arduino Uno board.

Please make sure pins are connected properly.

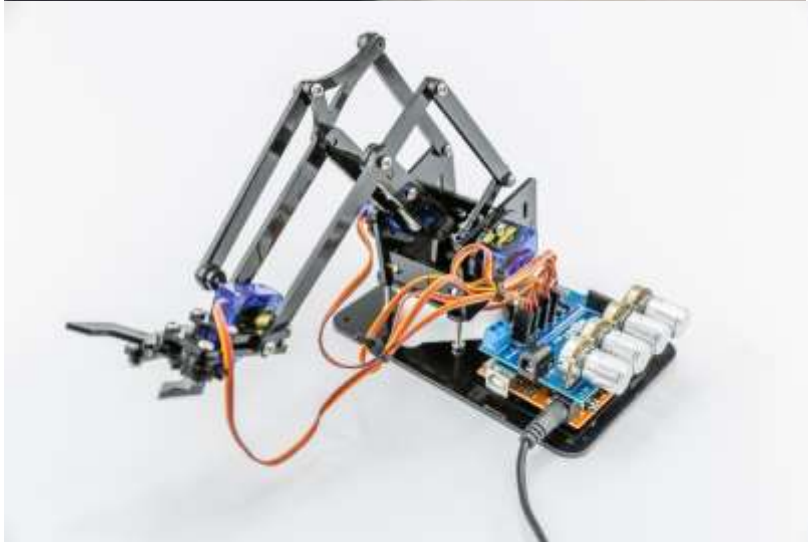

Then place the Robot Arm System on the Base servo rack and fasten it onto the base servo with a tapping screw.

Now you have finished all the installation!

### 6.2. Rack debugging

Now it's time to connect your servos to your Arduino UNO.

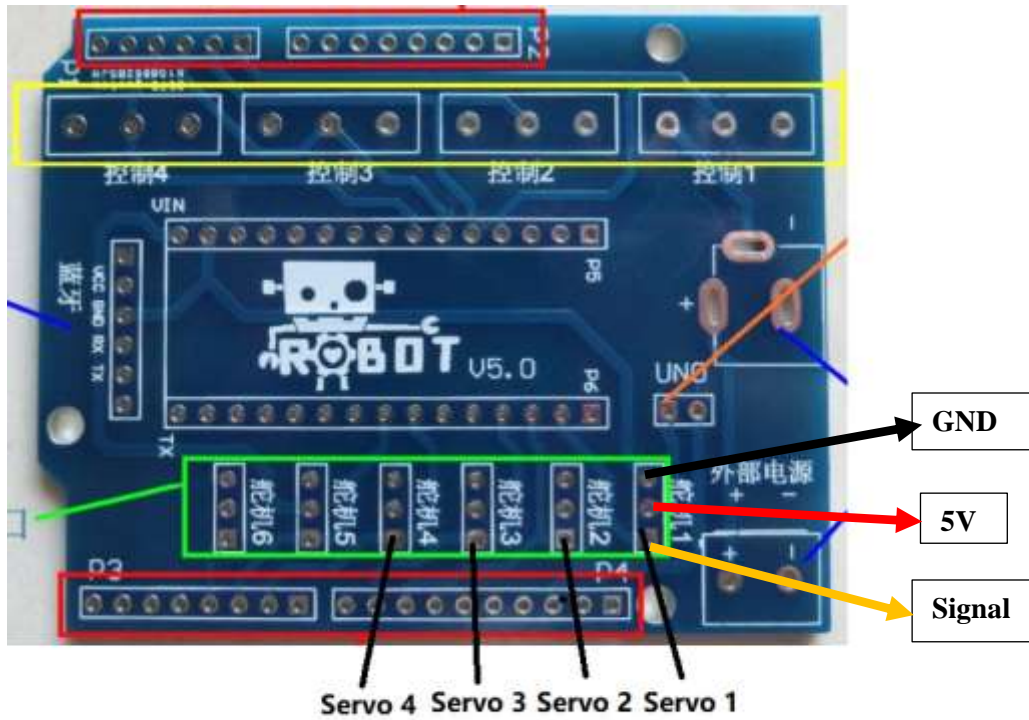

Servo 1	Claw servo
Servo 2	Main servo
Servo 3	Forearm servo
Servo 4	Rotation servo

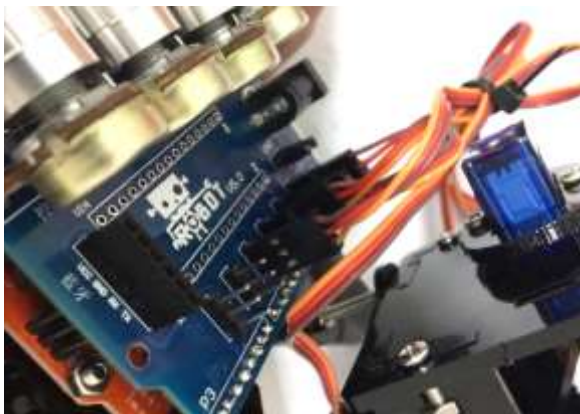

Take your time and do the proper wiring following the above instruction.

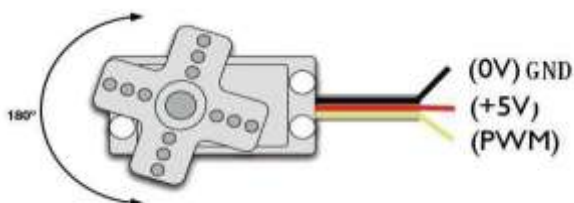

Servo has three pins:

- Signal
- GND
- VCC

### 6.3. Overall system debugging



Before we turn on the power, there are several things we still need to be check:

- a) Make sure each joint can rotate smoothly otherwise it would drive a large amount of current in the servo which leads to “Blocked” situation and the servos could be easily burnt out
- b) Adjust the potentiometer to suit the comfortable servo working range. The servo can work the angle: 0 ~ 180 degree without any restriction, but for this particular project the servo cannot due to the mechanical structure. Thus, it is critical to alter the potentiometer to proper position. Otherwise, if any one of the four servo gets stuck, the servo would drain a large current in which may cause irreparable damage to the servos.
- c) Change the potentiometer smoothly and slowly as servos require time to turn
- d) Power supply options: provide consistent and stable power supply for servos operations

## Chapter 7. Have fun with your arm robot

### 7.1. Manually control

For manual control; with the jumper cap inserted on the Robot Arm Extension Board, you can control your Robot Arm by adjusting the four potentiometers.

### 7.2. PC control interface

In this section, you can control your Robot Arm by connecting USB port to Iduino UNO Board. With Serial Communication via USB cable, the command is sent from the Upper Computer Software which is only available for Windows users for the moment.

Firstly, copy the new upper computer software control code to your Arduino UNO Board.



```
Upper_Computer_Software_Control | Arduino 1.8.4
File Edit Sketch Tools Help

Upper_Computer_Software_Control

// Control the microcontroller via serial
//
#include <Servo.h>

//SERVO OBJECTS
Servo servo1;
Servo servo2;
Servo servo3;
Servo servo4;

//servo positions values, expects 0-180 deg.
int servo1Pos = 90;
int servo2Pos = 90;
int servo3Pos = 90;
int servo4Pos = 90;
//int servo1Pos = 180; //Comment for 5 servo arm setup
//int servo2Pos = 180; //Comment for 6 servo arm setup

// Variables
char sendPacketChar; //Data is sent via fixed length set of integers, terminated by a Char, Example Packet: 10
// Constants
const char servoIDPC = "A"; // If "A" then serial data packet is Servo position values
//***** HIT SERVO SPEED VALUE *****
4
```

Double click the  
“Upper\_Computer\_Software\_Control.ino”.

Then hit the upload button.



NEW! ARDUINO 2.0 ROBOTIC ARM KIT @ WWW.MICROBOTLABS.COM

**MICROBOTLABS**

The MeCon App includes sample Arduino source code for controlling robot servo motors via your PC com port. Manual control as well as record and play back motion path files. Arduino example code shows how to control servo position update speed and reverse motor rotation via commands to the microprocessors serial port (USB port). MeCon allows for quick motion control without having to learn code and or build addition electronic circuitry.

[Download MeCon Robot Servo Control Software Version 1.4 - Extended Features With Kit Password](#)

**MeCon Version 1.4**  
Incorporated all of previous dev releases. Added pause and rewind buttons for motion path playback. Edited some text and labels to improve usability. Disabled old "config" comport settings. Fixed missing line bug with looped playback option.

Download the software application from [here](http://microbotlabs.com/software.html): <http://microbotlabs.com/software.html>, credit to microbotlab.com.

Chapter 7  
Have fun with your arm robot



Open the app and press OK to continue



Please plug in Arduino USB before starting Mecon software for auto port detection or use the “Scan for Ports” button to refresh available ports.

Choose the USB port.



In this case to demonstrate, we are using COM6.

This COM number may vary case by case. Please check the Device Manger for correct COM port number.

## Chapter 7

### Have fun with your arm robot



Control Robot Arm by sliding the servo 1/2/3/4 Bars

Now it's time to have fun! Turn the power on, and see how your DIY Arduino Robot Arm goes! After final assembly and activation, the Robot arm may require adjustments and debugging. The Robot will perform on how it is programmed. Figuring out what the code is doing is part of the learning process. Reopen your Arduino IDE and we assure you will learn a lot once you gain a deep understanding of the code.

**Please unplug the Sensor board from the Arduino UNO board and disconnect 18650 power box supply to modify your code.** Otherwise, it may cause irreparable harm to your Robot and PC as it may drive a large current through your USB port.

This kit is just a starting point and can be expanded to incorporate other sensors and modules. You are limited by your imagination.

We are also offering other Arduino Robot Kit versions where you can learn WIFI, Bluetooth, infrared remote control and so many more.

- [Arduino 4 Wheel Drive with Ultrasonic & Line Tracer Bluetooth Robot Kit](https://www.auselectronicdirect.com.au/arduino-4-wheel-drive-with-ultrasonic-line-tracer~3691)  
(<https://www.auselectronicdirect.com.au/arduino-4-wheel-drive-with-ultrasonic-line-tracer~3691>)
- [Arduino 4 Wheel Drive with Ultrasonic & Line Tracer Robot Kit](https://www.auselectronicdirect.com.au/arduino-4-wheel-drive-with-ultrasonic-line-tracer~3691)  
(<https://www.auselectronicdirect.com.au/arduino-4-wheel-drive-with-ultrasonic-line-tracer~3691>)
- [Arduino 2 Wheel Drive Wireless Bluetooth Robot Kit](https://www.auselectronicdirect.com.au/arduino-2-wheel-drive-wireless-bluetooth-robot-kit)  
(<https://www.auselectronicdirect.com.au/arduino-2-wheel-drive-wireless-bluetooth-robot-kit>)
- [Arduino Robot Arm 4dof Mechanical Claw Kit](https://www.auselectronicdirect.com.au/arduino-robot-arm-4dof-mechanical-claw-kit)  
(<https://www.auselectronicdirect.com.au/arduino-robot-arm-4dof-mechanical-claw-kit>)

Check our website for more at [Here.](https://www.auselectronicdirect.com.au/arduino/arduino-starter-kit/) (<https://www.auselectronicdirect.com.au/arduino/arduino-starter-kit/>)