

User manual

For

Arduino Bluetooth Car Kit

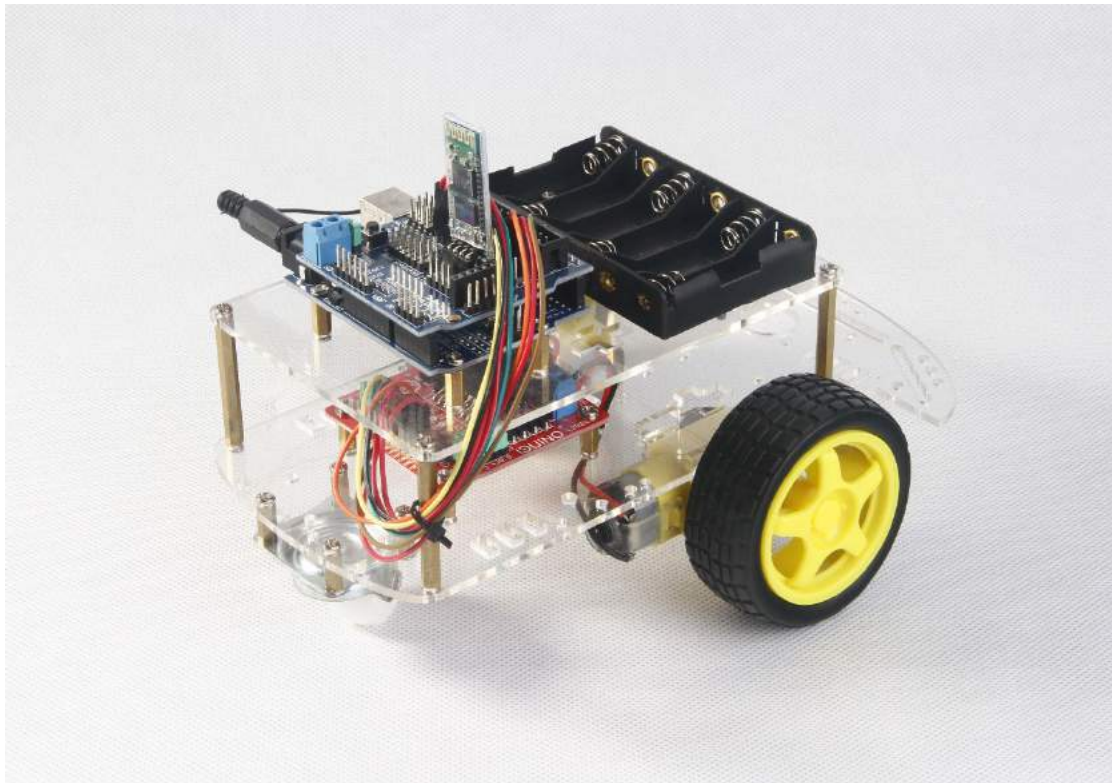

Introduction:

This Bluetooth DIY car is based on Arduino development board(open source electronic platform). In this manual, we mainly use four Arduino parts: UNO board(Compatible with arduino); Bluetooth HC-06 module; L298N motor driver board; Arduino sensor extension board. All of this parts are very common used in Arduino project. And if you want to learn or use other module like infrared received module, Ultrasonic module; or RF module, just replace Ultrasonic module with these module, then you can make an infrared remote car or Bluetooth car and so on...

Component list

- Arduino compatible UNO R3 *1
- L298N motor driver board*1
- Arduino sensor extension board *1
- Bluetooth HC-06 module *1(Default password:1234)
- Car chassis *2
- Car Wheels 2
- DC Gear Motor(1:48) *2
- 10 line encoder *2
- Universal wheel*1
- 6AA battery box *1
- Some Jumper
- Several screw nut



Install steps

Step1: install the car chassis

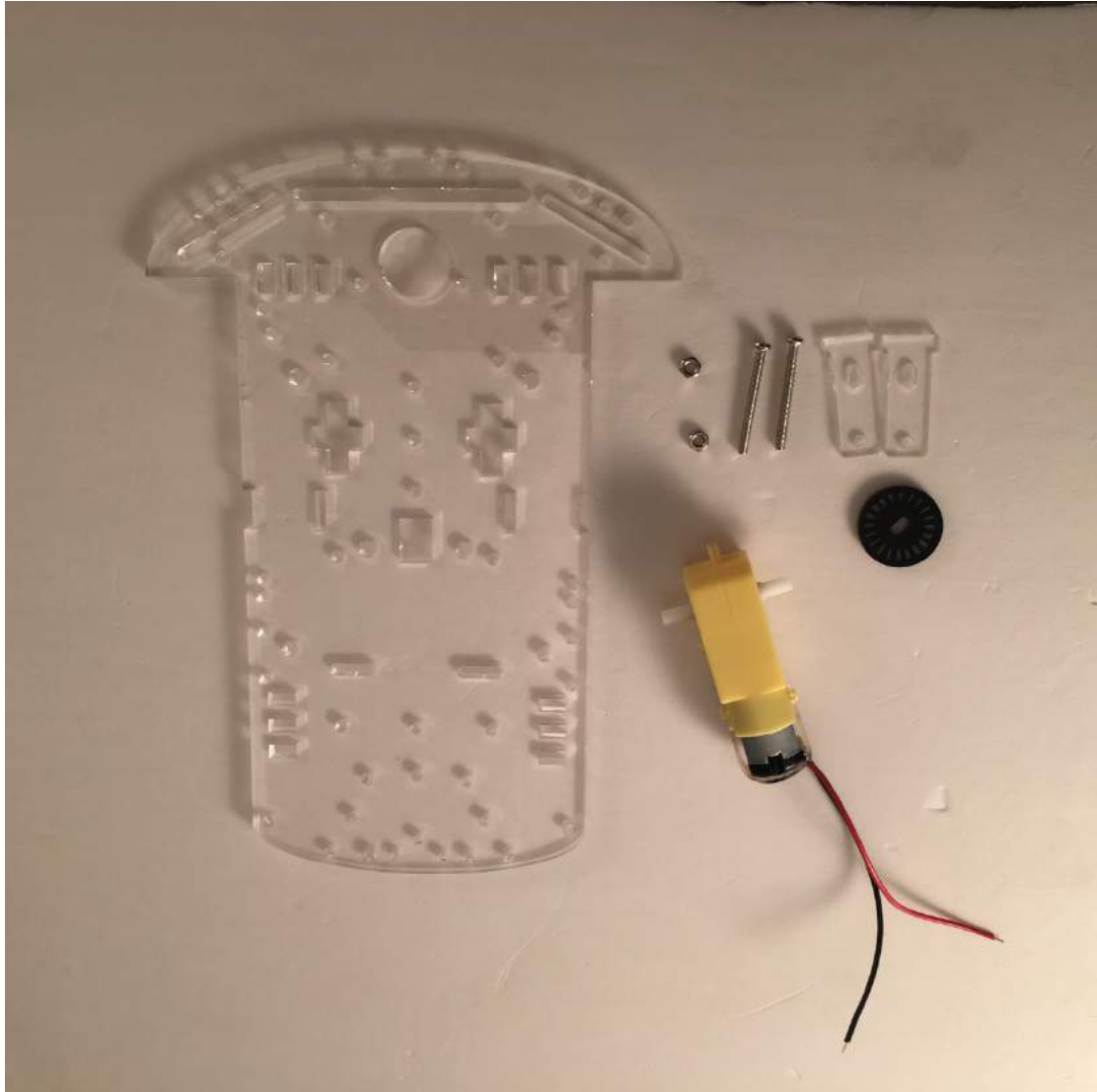

Firstly, You need plug the encoder in the motor.

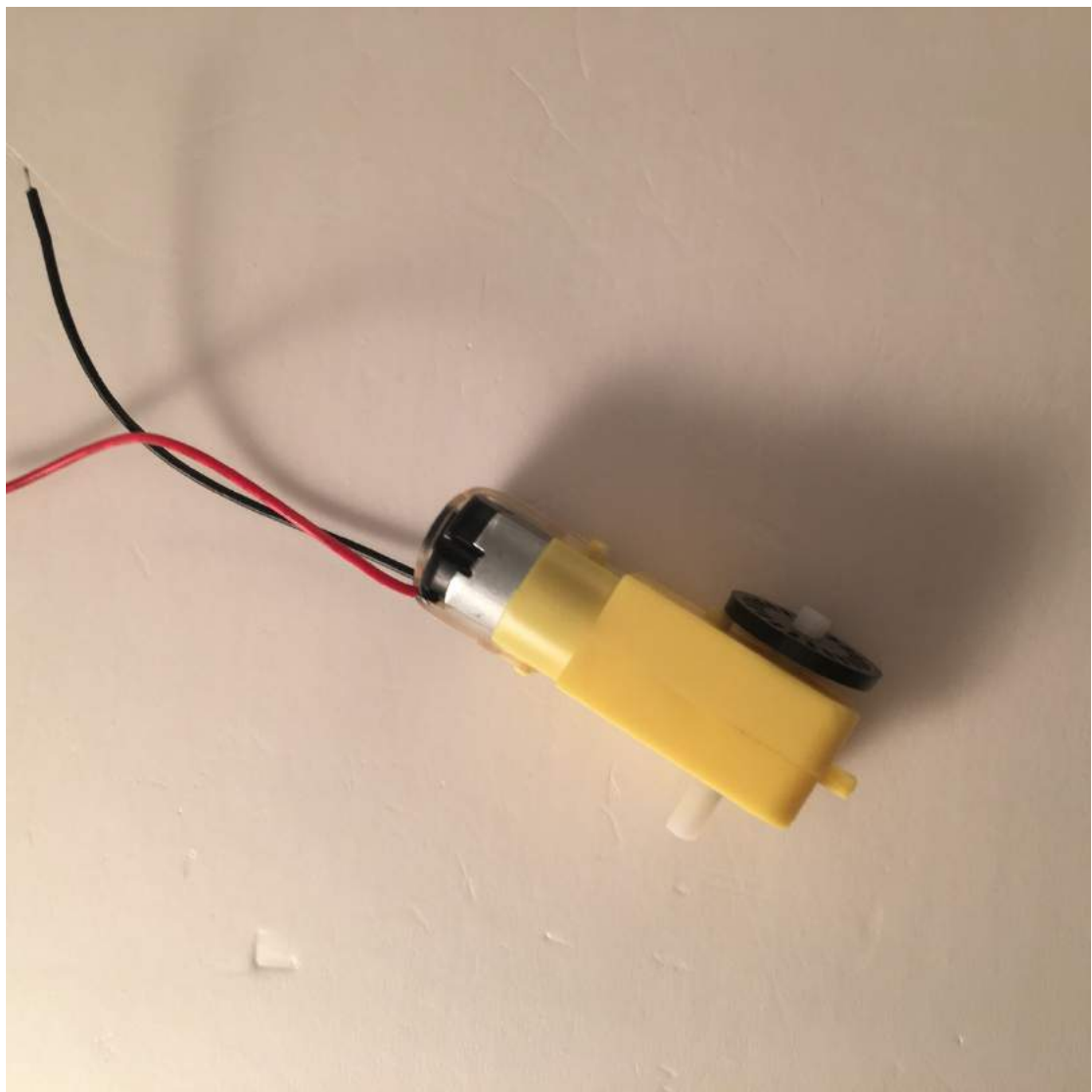

Second, use 2 fasteners to fix one motor on the bottom board. Please note which hole should be used and the motor's direction should be forward.

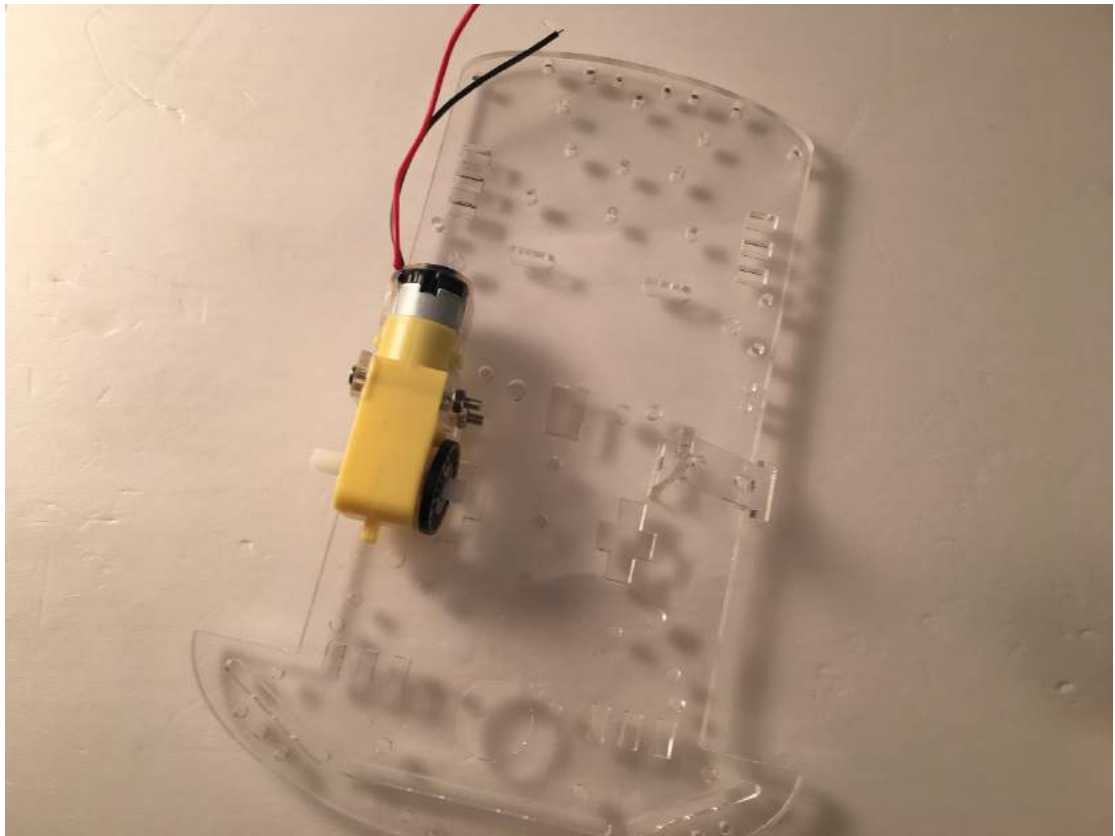
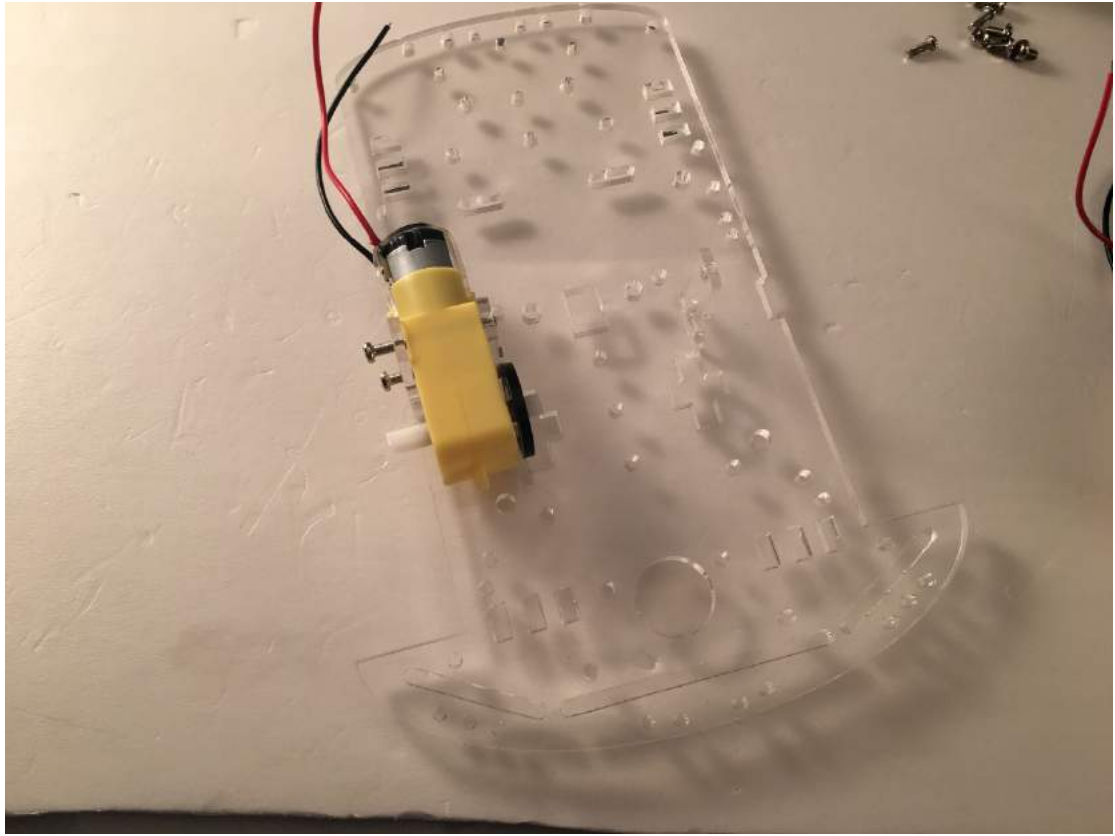

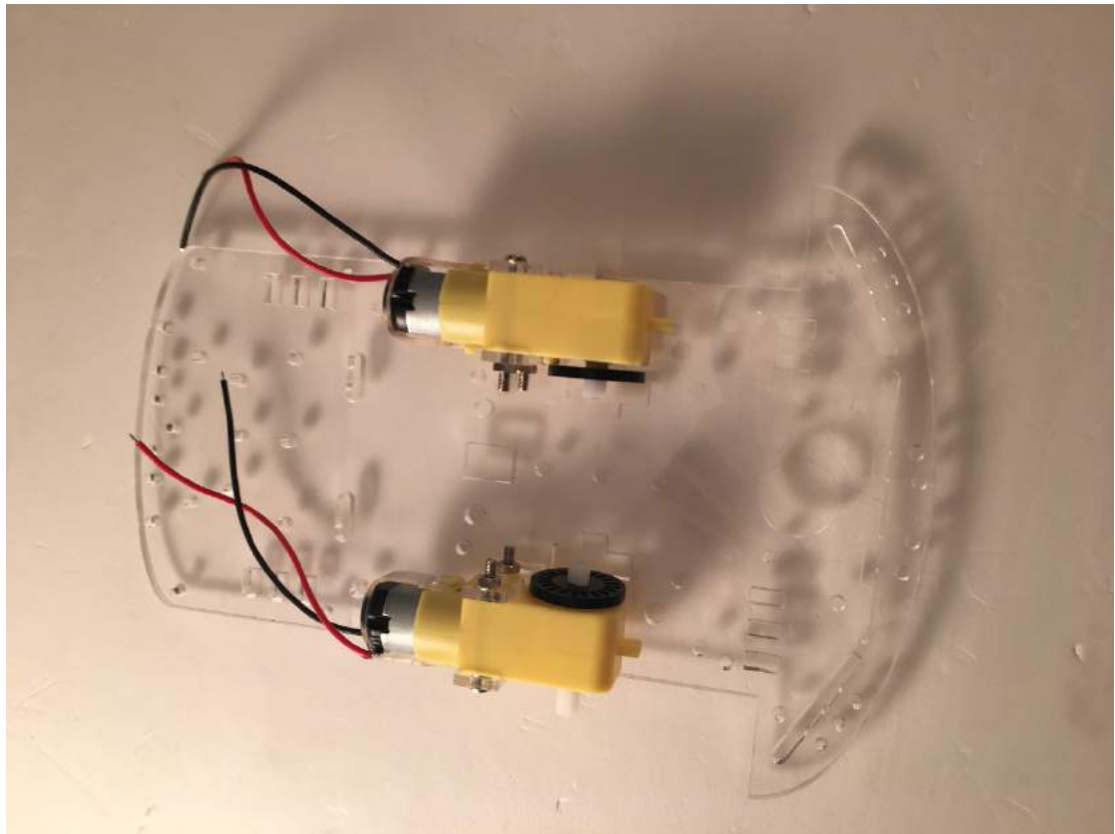

Plug the rubber wheel in the motor, please note the angle of the socket on the wheel.

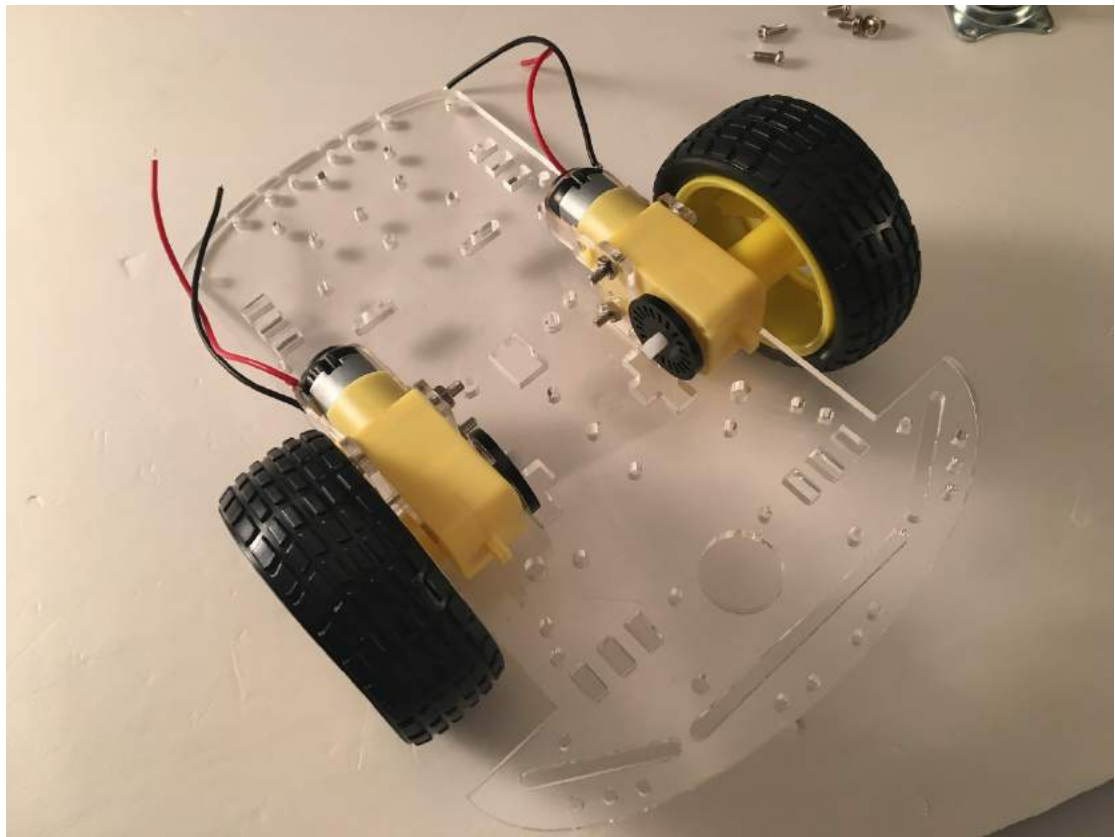

Then, install the universal wheel, please note which hole should be used on the board.



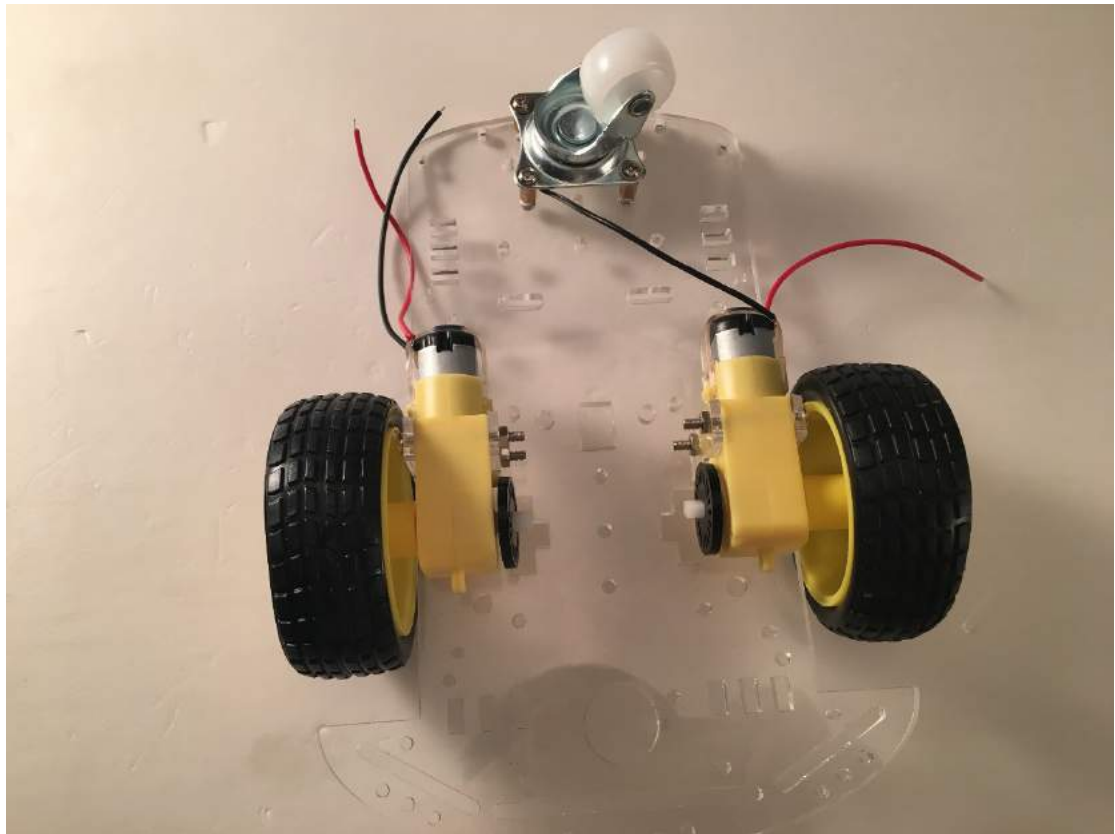

Then the first step finished as the following picture:

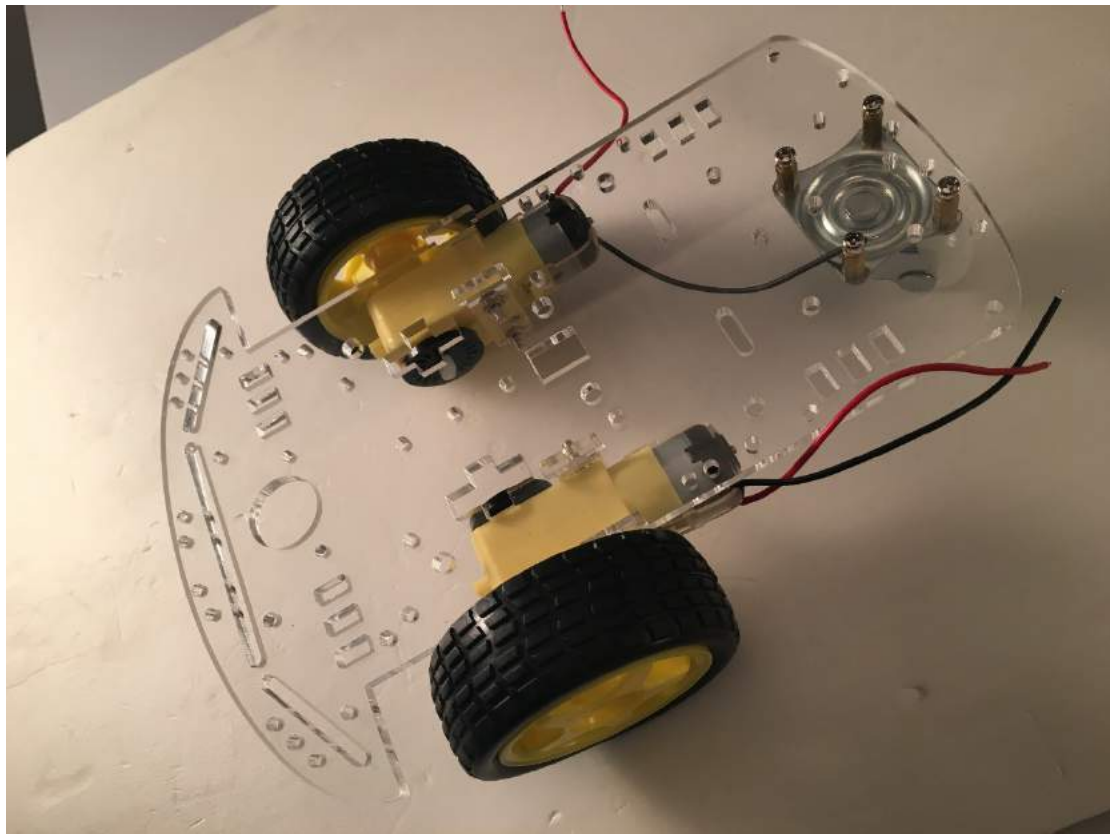

Step2: Fix the main components on the car chassis

First, Fix the L298N driver board.

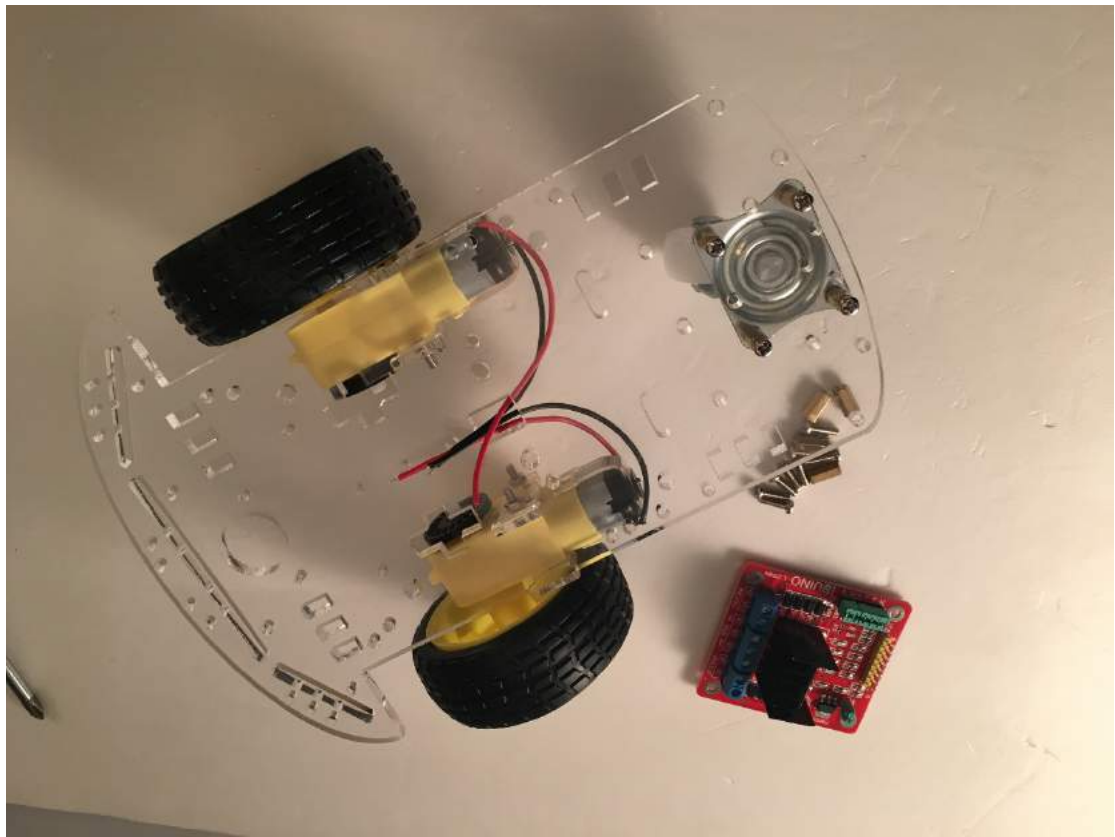

Before you fix the screw, passing the wire on the motor through the board helps your next step.

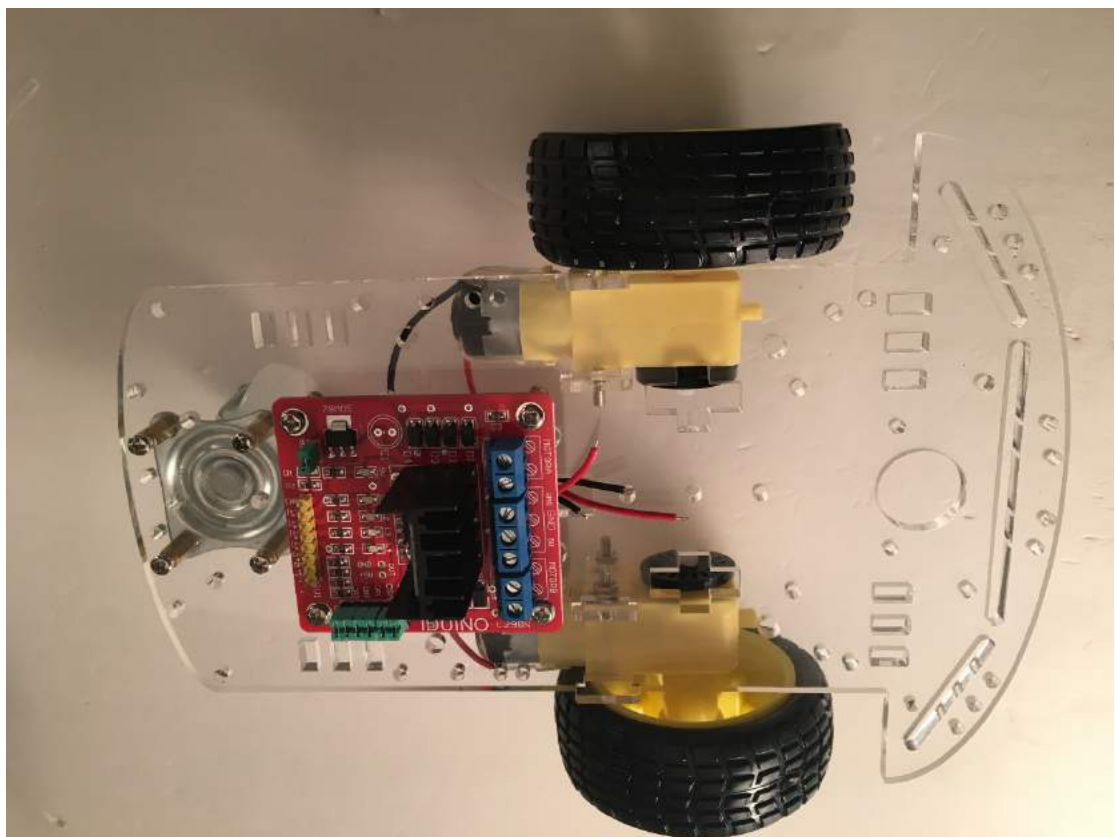

Then connect the L298N module with the motor, please note which wire should be fixed on which screw, the red wire is VCC and the black wire is GND.

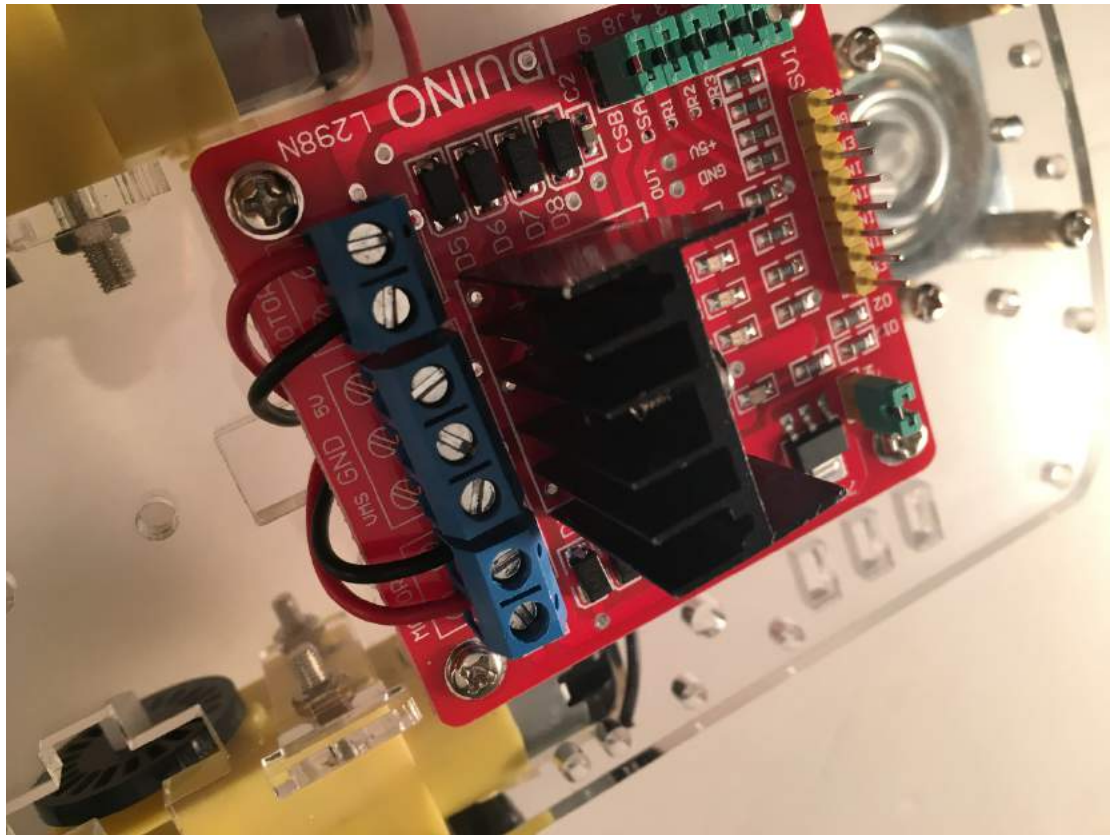

We have other three parts need to be fixed, the UNO board, sensor extension board and ultrasonic module. If we put these part also on the one acrylic board used on the above step, the space may be crowded, which makes the appearance of the ultrasonic car not beautiful. So in the next step, we can use another acrylic board. We can fix the UNO and battery box on the acrylic board first, then fix the new board on the bottom board.

Please note the needed fix hole.

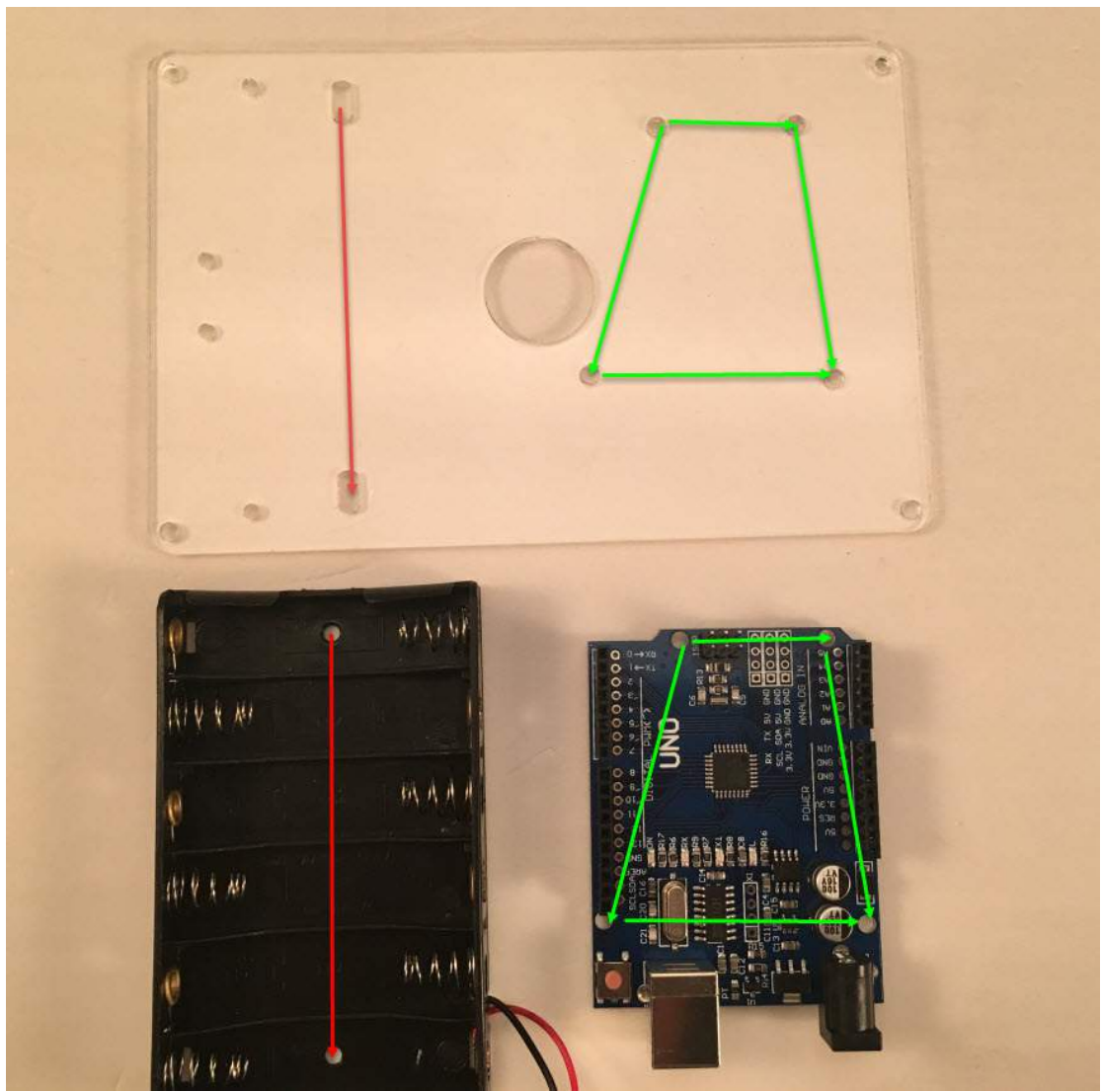

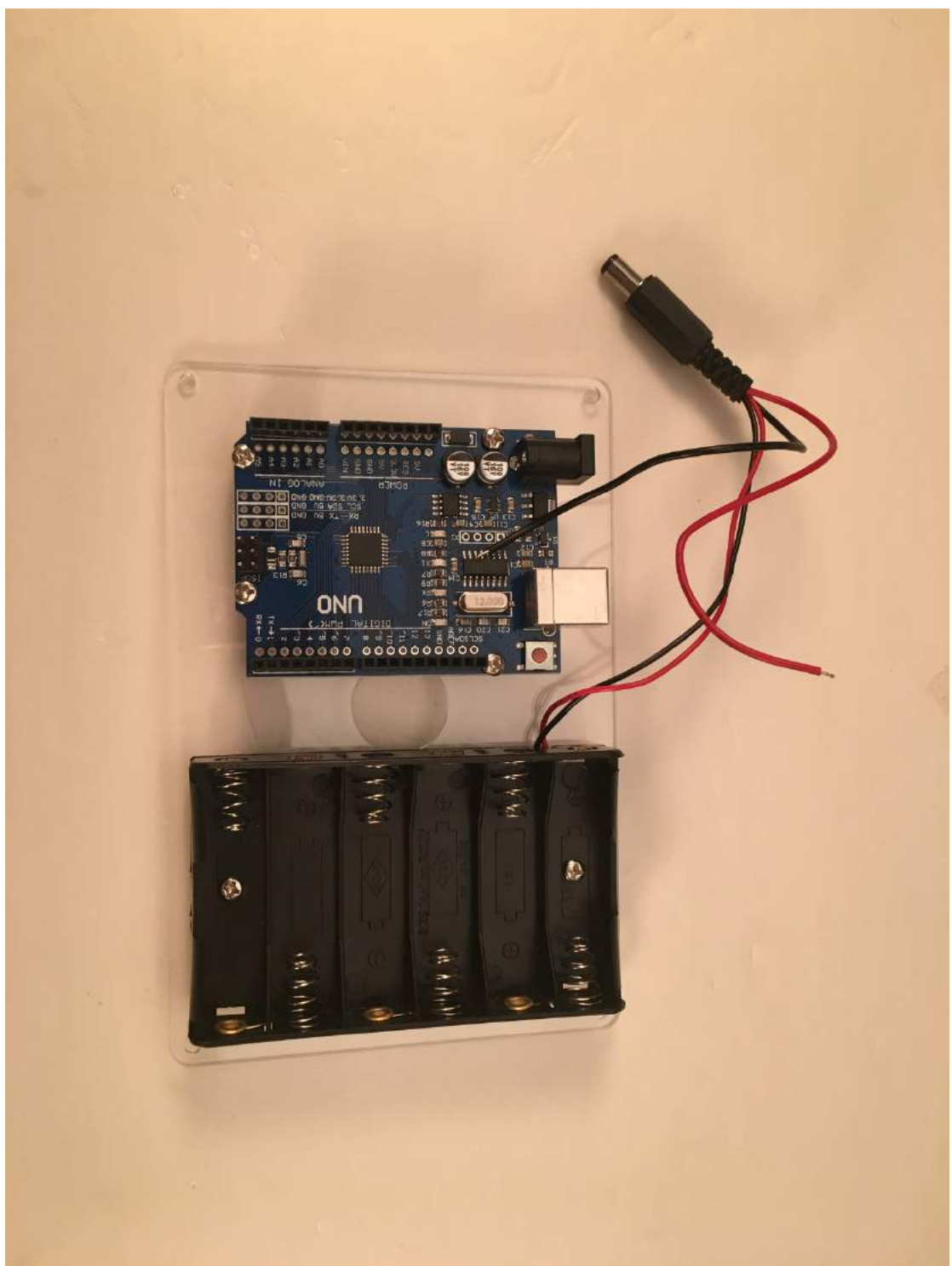

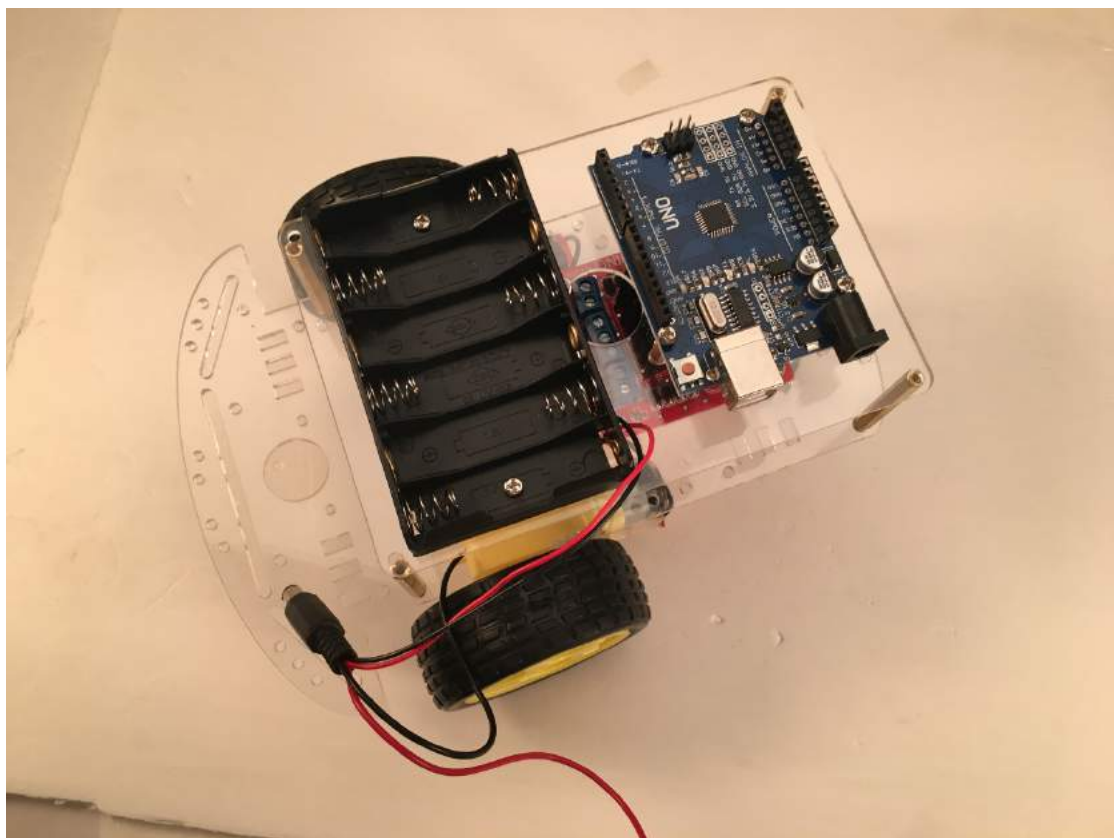
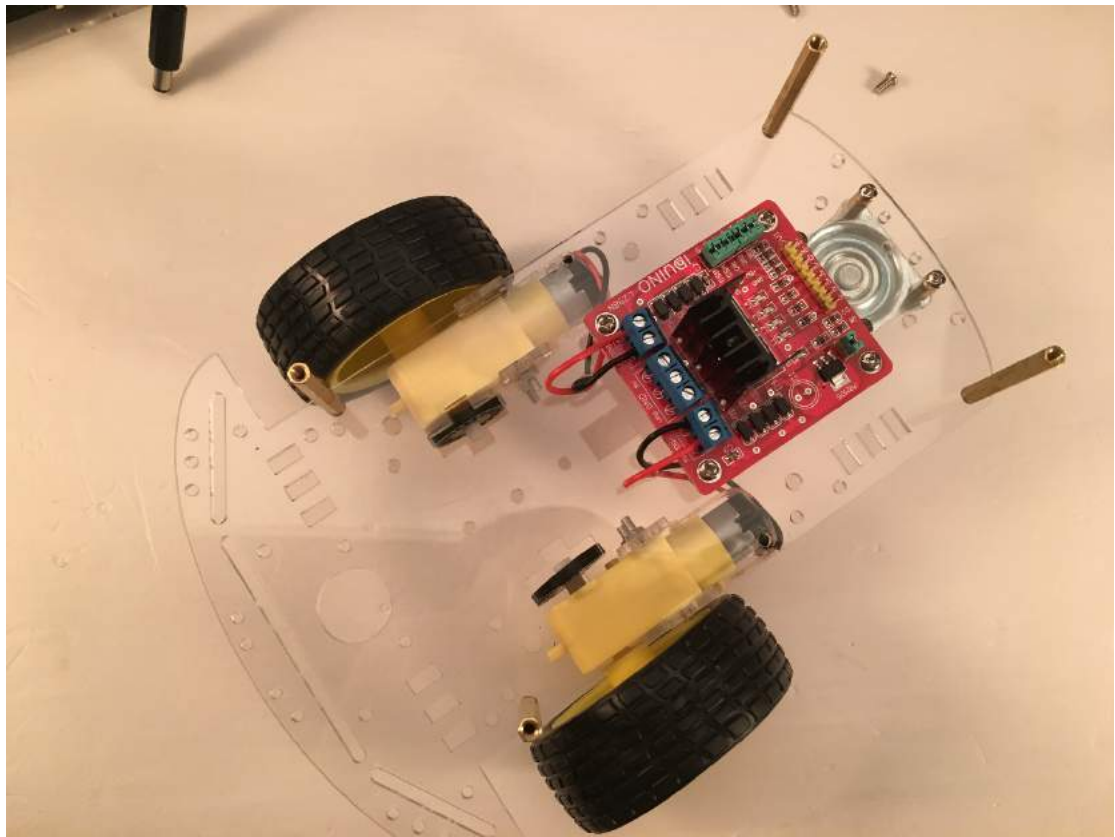

After above, directly plug the sensor extension board to the uno board, the install is finished.

Step 3: Wire connection and upload code.

In this step, we need connect wire as the following picture.

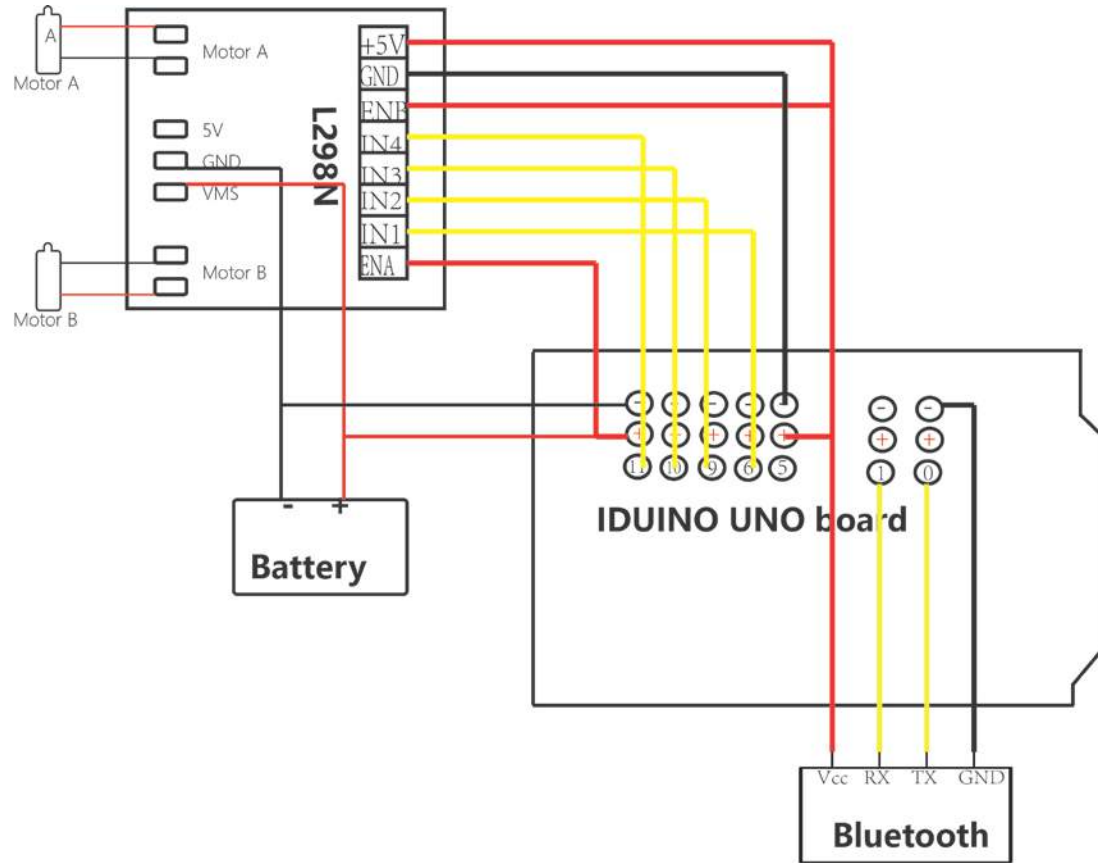

For the Bluetooth module, you can directly plug into the sensor extension board as the below picture show.

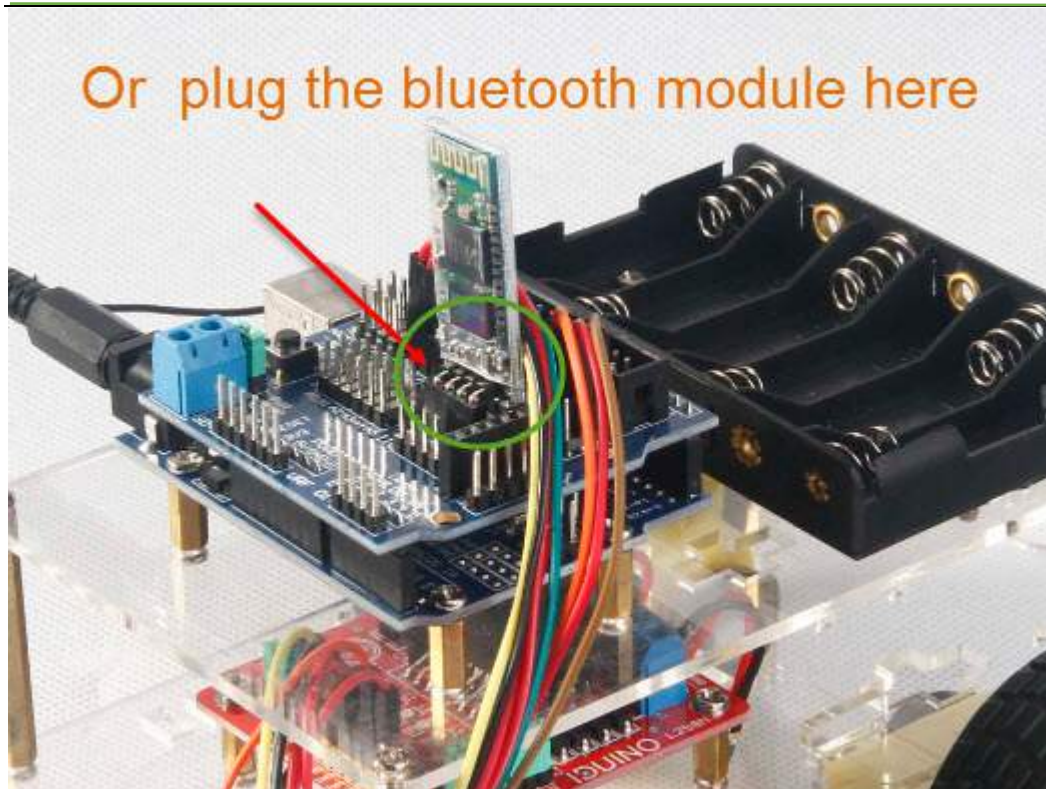

After the connection, upload the following code to your UNO board. Then power on the uno board and L298N module.

Now, you can control this DIY Bluetooth car by your computer or your cellphone. Before that, you need download the Bluetooth Serial software for your cellphone first, we offer one for Android device, for the IOS user, we not find suitable one. After upload the code, open the App, and connect the HC-06 bluetooth device, of course you need open your cellphone's Bluetooth function first. Then type the corresponding character to control the car, which character can be change through the code. By default, the character means that:

F, means Move Forward;

L, means Turn Left;

R, means Turn Right;

B, means Move Back;

S, means Stop moving.

*****Code begin*****

```
int MotorRight1=8;
```

```
int MotorRight2=9;
```

```
int MotorLeft1=10;
```

```
int MotorLeft2=11;

void setup()
{
  Serial.begin(9600);
  pinMode(MotorRight1, OUTPUT);
  pinMode(MotorRight2, OUTPUT);
  pinMode(MotorLeft1, OUTPUT);
  pinMode(MotorLeft2, OUTPUT);
}

void go()// Forward
{
  digitalWrite(MotorRight1,LOW);
  digitalWrite(MotorRight2,HIGH);
  digitalWrite(MotorLeft1,LOW);
  digitalWrite(MotorLeft2,HIGH);
}

void left() //Turn left
{
  digitalWrite(MotorRight1,HIGH);
  digitalWrite(MotorRight2,LOW);
  digitalWrite(MotorLeft1,LOW);
  digitalWrite(MotorLeft2,HIGH);
}

void right() //Turn right
{
  digitalWrite(MotorRight1,LOW);
  digitalWrite(MotorRight2,HIGH);
  digitalWrite(MotorLeft1,HIGH);
  digitalWrite(MotorLeft2,LOW);
}

void stop() // Stop
{
  digitalWrite(MotorRight1,LOW);
  digitalWrite(MotorRight2,LOW);
  digitalWrite(MotorLeft1,LOW);
  digitalWrite(MotorLeft2,LOW);
}
```

```
}
void back() // Back
{
    digitalWrite(MotorRight1,HIGH);
    digitalWrite(MotorRight2,LOW);
    digitalWrite(MotorLeft1,HIGH);
    digitalWrite(MotorLeft2,LOW);

}

void loop()
{
    char val = Serial.read();
    Serial.write(val);
    if (-1 != val) {
        if ('F' == val)
            go();
        else if ('L' ==val)
            left();
        else if ('R' == val)
            right();
        else if ('B' == val)
            back();
        else if ('S' == val)
            stop();
        delay(500);
    }
    else
    {
        //stop();
        delay(500);
    }
}
}
*****Code End*****
```

Above all, the DIY Bluetooth Arduino car finished. This car kit offer you a learning platform, because basing on this car, you can learn other project module(Ultrasonic, infrared remoter and wifi video module), and make your smart car. Even the chassis also can replace a more powerful one, also a tank chassis, that's would be very fun~~