

# INSTRUCTION MANUAL

1/10 Scale 4WD RC Nitro & Electric Powered Car

## SWORD XXX EBD/EBL



RH901 - EBD (Brushed)

RH902 - EBL (Brushless)

## SWORD XXX N1/N2



RH903 - N1 (Single Speed)

RH905 - N2 (Two Speed)

## 1/10 Scale 4WD RC Nitro Powered Car

**RH903 Sword XXX N1** (Single Speed)

**RH905 Sword XXX N2** (Two Speed)

### RH903 Specs :

1. Length: 515 mm (N1)
2. Width: 325 mm (N1)
3. Height: 180 mm (N1)
4. Wheelbase: 325 mm
5. Gear Ratio: 10.4:1
6. Tyre:  $\phi 130 \times 65$  mm (N1)

### RH905 Specs :

1. Length: 515 mm (N2)
2. Width: 325 mm (N2)
3. Height: 180 mm (N2)
4. Wheelbase: 325 mm
5. Gear Ratio: 6.9:1 (H)  
10.4:1 (L)
6. Tyre:  $\phi 130 \times 65$  mm

### Standard Equipments:

1. Steering Servo: 3kg/cm
2. Throttle Servo: 3kg/cm
3. Engine: G0.18 or SH 18

*HOT!*



**single speed**



**Two speed**



### Front Shocks

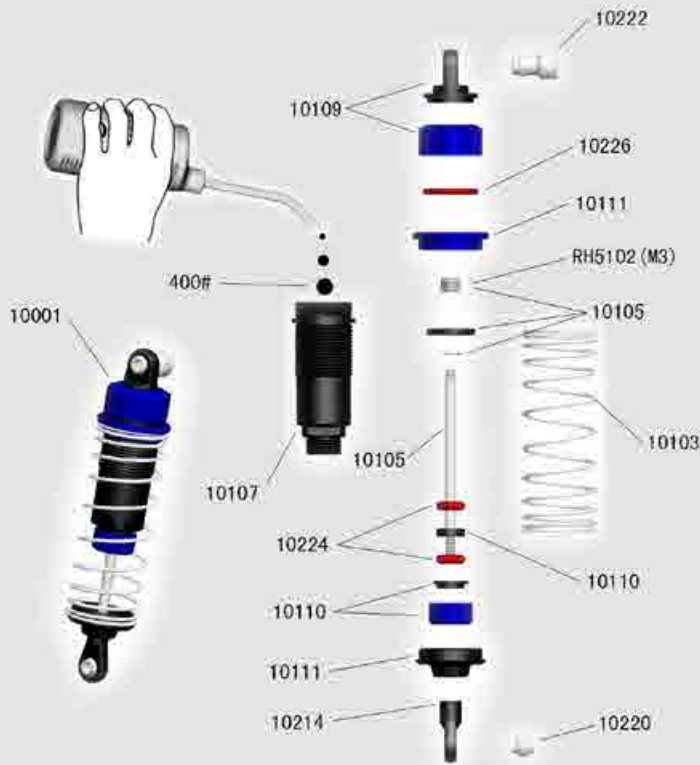

(Dia. 1-1)

### Rear Shocks

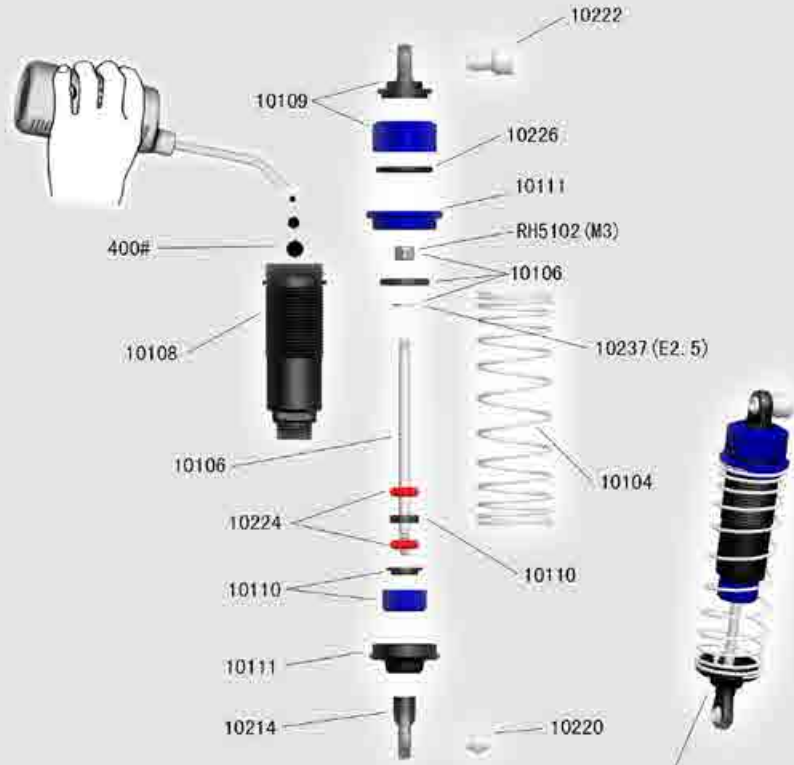

(Dia. 1-2)

### Chassis Assembly

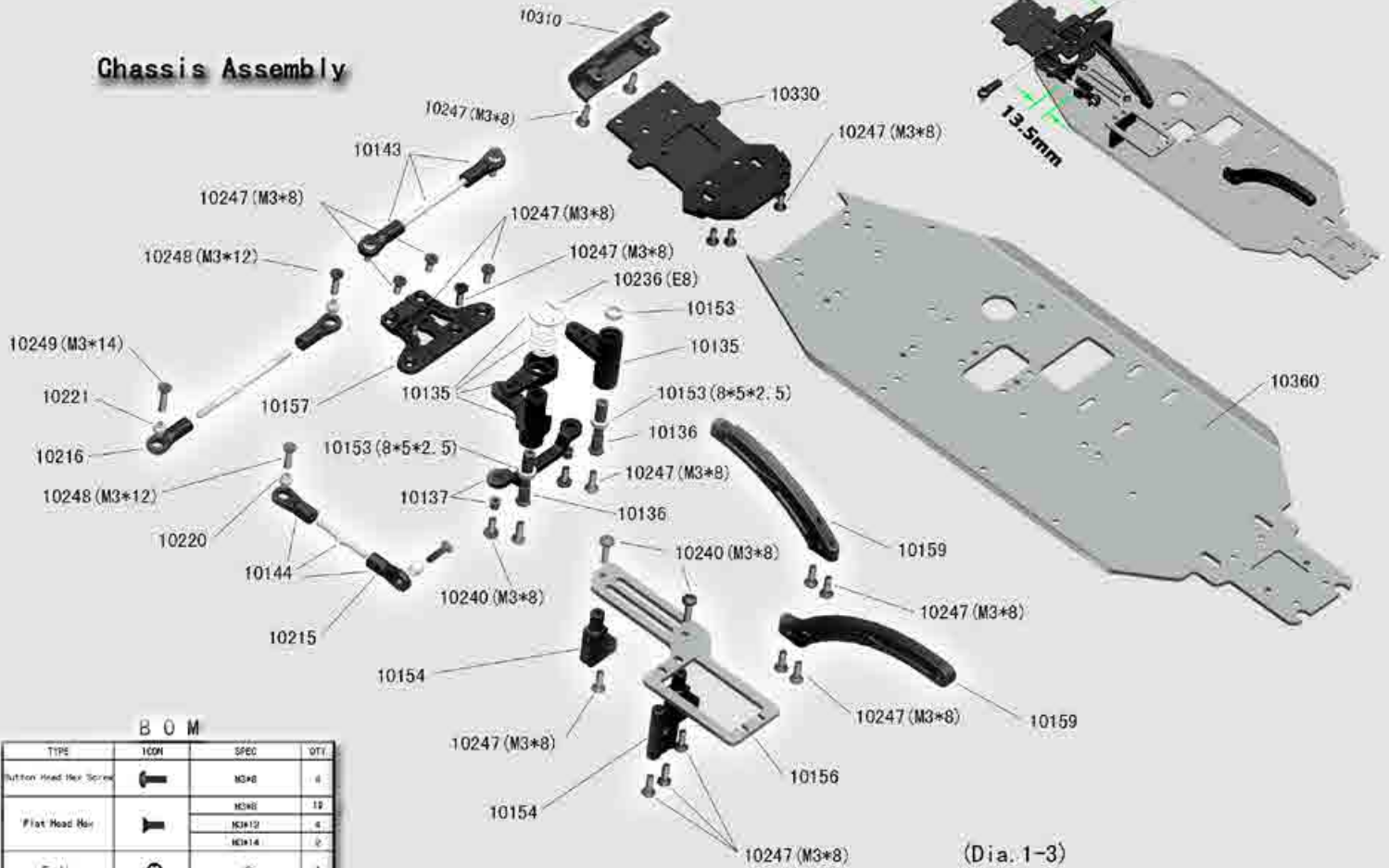

(Dia. 1-3)

#### B O M

TYPE	ICON	SPEC	QTY
Button Head Hex Screw		M3*8	4
Flat Head Hex		M3*8	18
		M3*12	4
		M3*14	2
E-clip		#5	1
Ball Bearing		dφxOx2.5	3

B O M

TYPE	ICON	SPEC	QTY
Round Head Self Tapping Hex Screw		M10	4
Button Head Hex Screw		M8 M10 M12	2 2 2
Cap Head Hex Screw		M8 M10 M12	2 2 2
Flat Head Hex		M8 M10 M12 M14 M16	2 2 2 4 2
Set Screw		M4 M6 M8 M10	1 1 1 1
Ring Self Tapping Screw		Ø4	2
Washer		M6x1.6 0.2	2
Nylon Lock Nut		M3	2
E-clip		M3	5
O-Ring		M5.5x4.5x1.5 M5.5x2.5x1.5 M5.5x1.5x1.5	4 4 2
Ball Bearing		M5x10x4 M5x8x4	2 2

Front Assebley

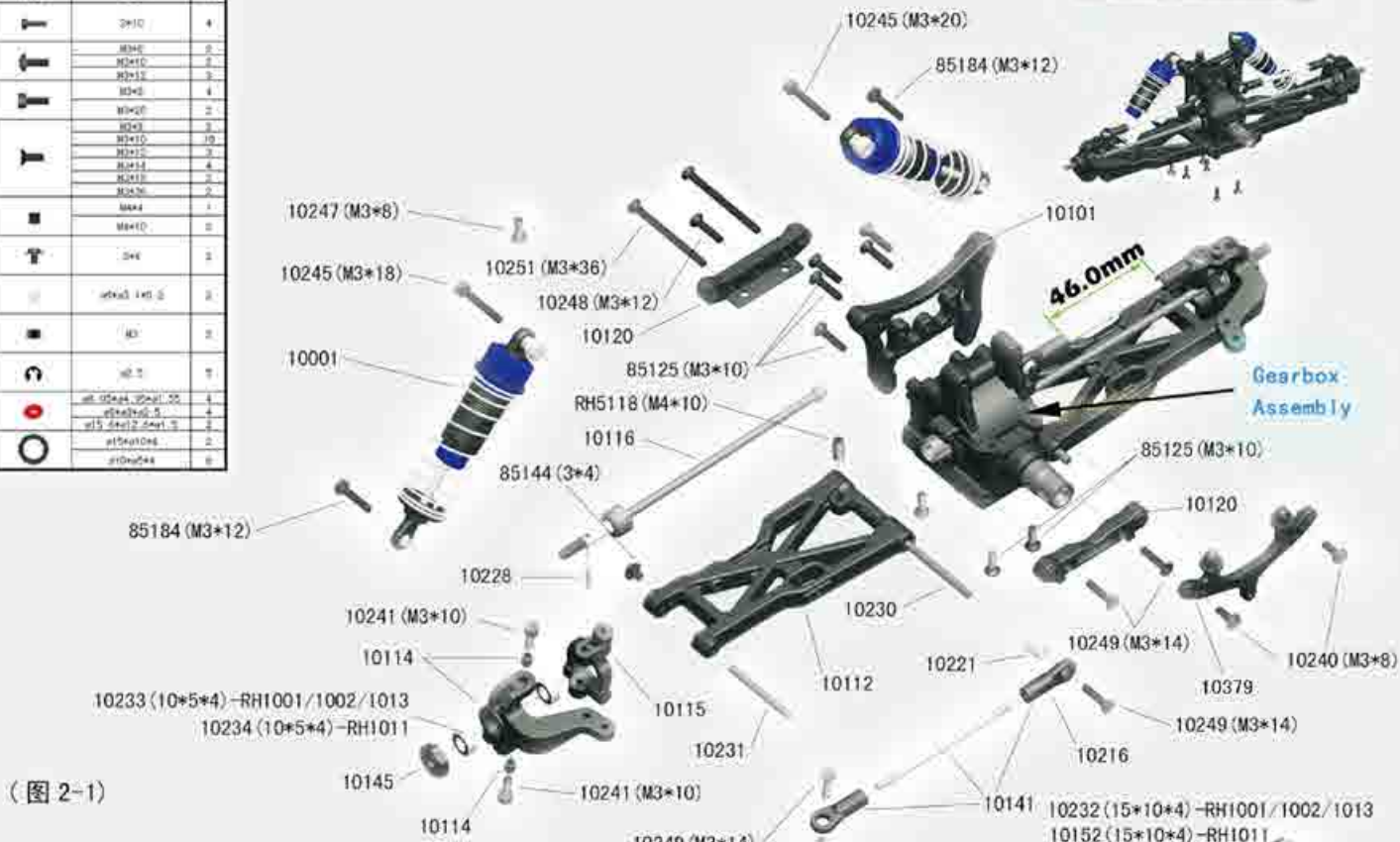

Gearbox Assmebly



Diff Box



Diff. Box

Rear Assebley

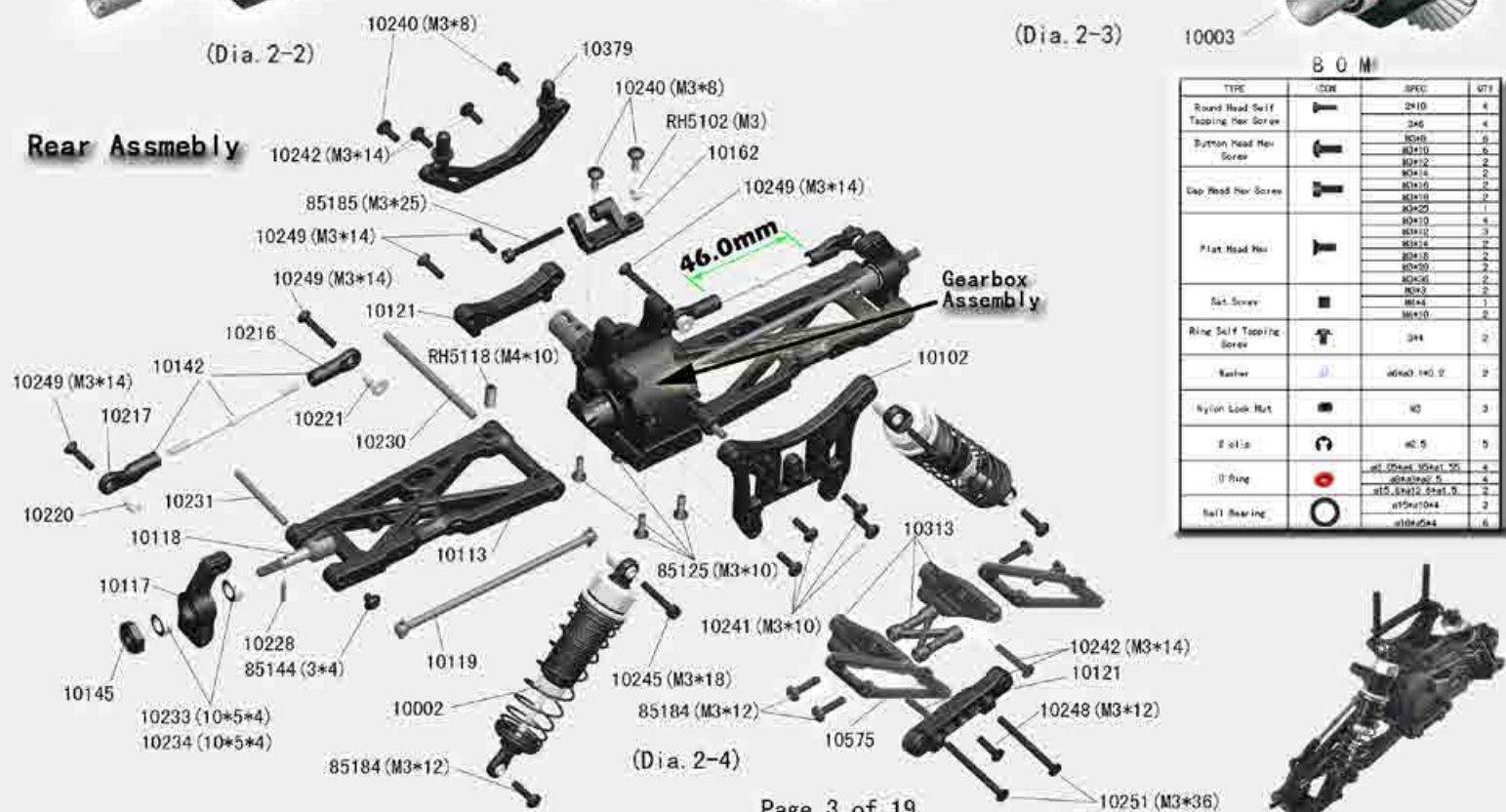

B O M

TYPE	ICON	SPEC	QTY
Round Head Self Tapping Hex Screw		M10	4
Button Head Hex Screw		M8 M10 M12	2 2 2
Cap Head Hex Screw		M8 M10 M12	2 2 2
Flat Head Hex		M8 M10 M12 M14 M16	2 2 2 2 2
Set Screw		M4 M6 M8 M10	1 1 1 1
Ring Self Tapping Screw		Ø4	2
Washer		M6x1.6 0.2	2
Nylon Lock Nut		M3	2
E-clip		M3	5
O-Ring		M5.5x4.5x1.5 M5.5x2.5x1.5 M5.5x1.5x1.5	4 4 2
Ball Bearing		M5x10x4 M5x8x4	2 2

**B O M**

TYPE	ICON	SPEC	QTY
Round Head Self Tapping Hex Screws		D40	4
Button Head Hex Screws		M40	4
Cap Head Hex Screws		M3*15	2
		M3*28	5
Flat Head Hex		M5*10	1
Set Screw		M4	1
Washer		ø14x3.1x0.2	1
Nylon Lock Nut		M3	3
O-Ring		901* 60	1
Ball Bearing		ø10x25x4	2

**Engine Assembly**

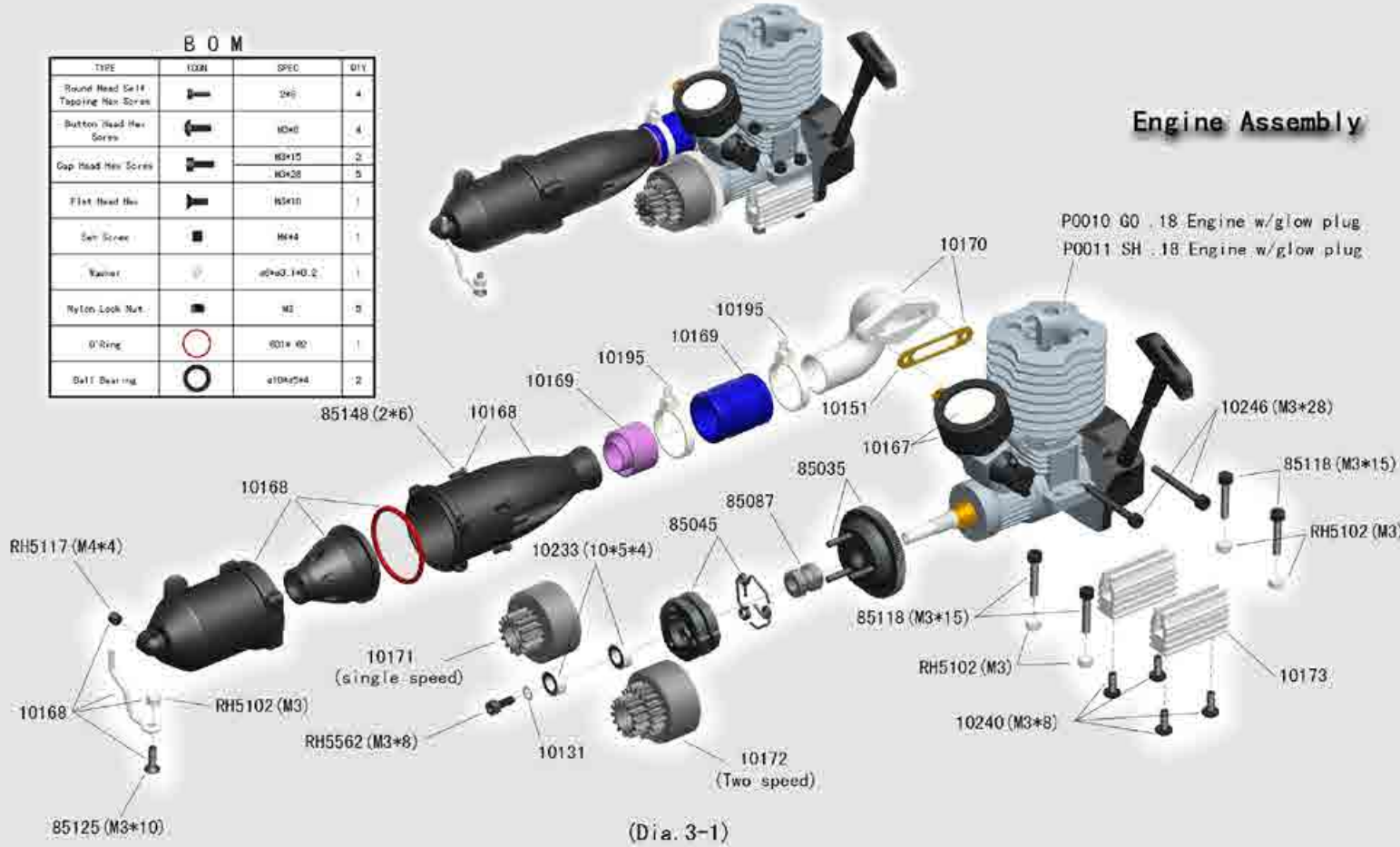

**DT N1 Central Transmission**

**B O M**

TYPE	ICON	SPEC	QTY
Cap Head Hex Screw		M3*10	2
Flat Head Hex		M3*0	4
		M3*10	2
Set Screw		M3*3	1
E-clip		M4	2
		all	3
Ball Bearing		ø10x25x4	2

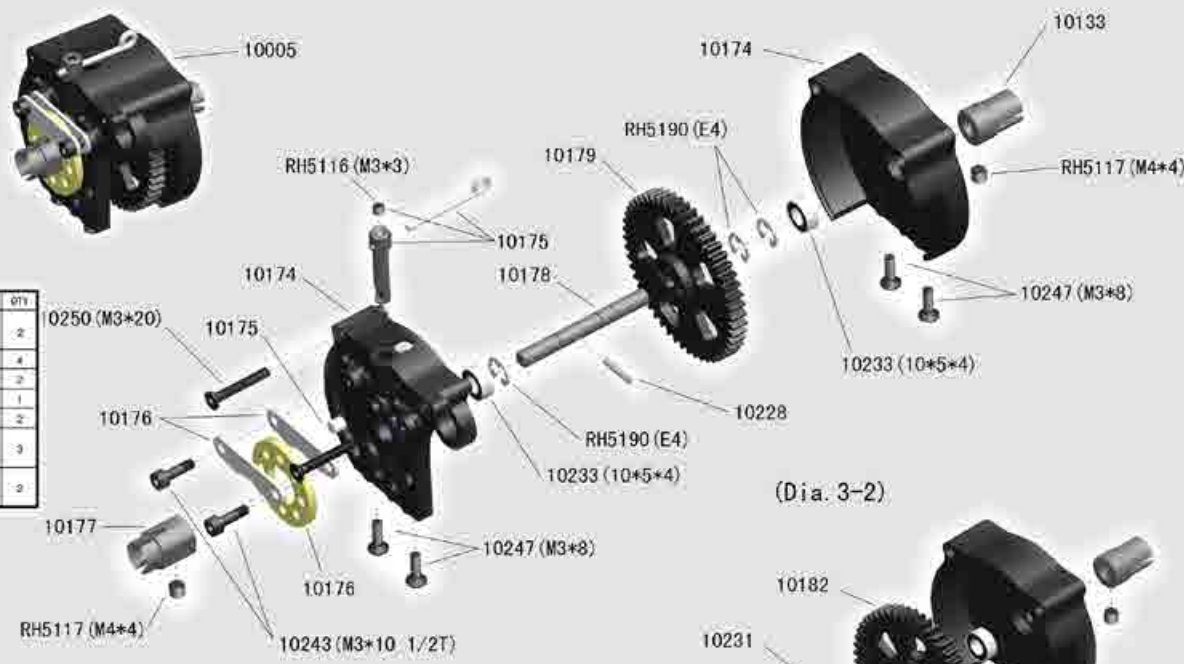

**DT N2 Central Transmission**

**B O M**

TYPE	ICON	SPEC	QTY
Cap Head Hex Screw		M3*10	2
Flat Head Hex		M3*0	4
		M3*20	2
Set Screw		M3*3	1
E-clip		M4	4
		all	1
One Way Bearing		ø12x6.2x6.4	1
Ball Bearing		ø10x25x4	2

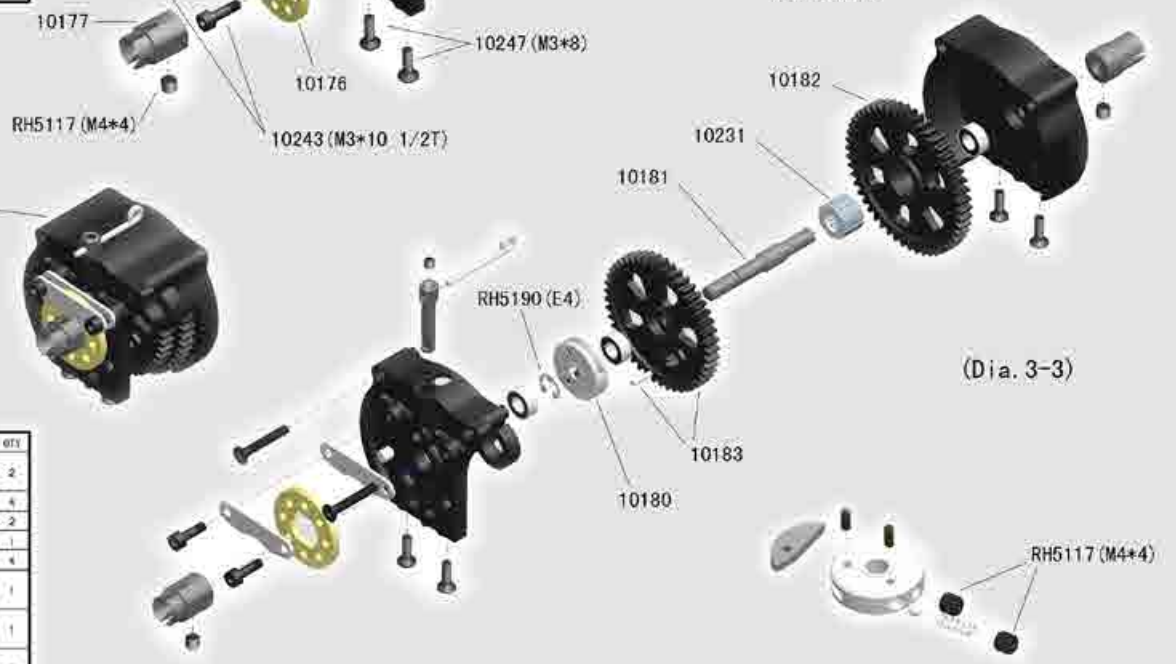

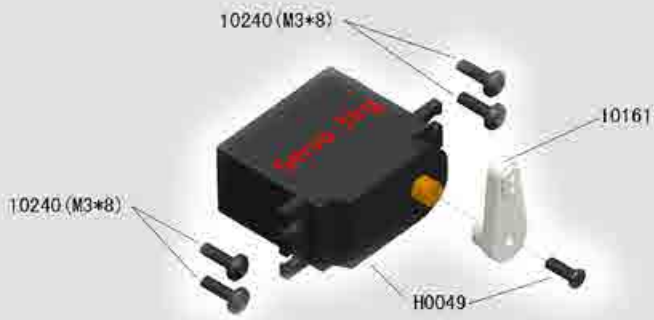

**Steering Servo**



(Dia. 4-1)



**Throttle Linkage**



(Dia. 4-2)

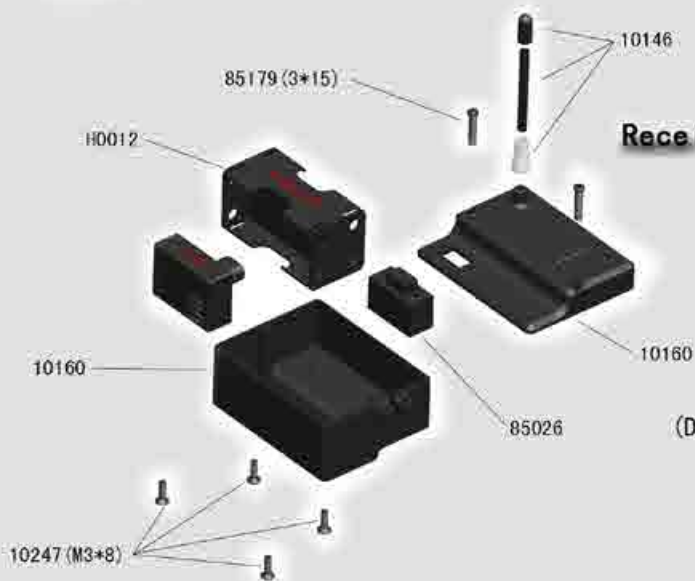

**Receiver Assembly**



(Dia. 4-3)

**Fuel Tank**



(Dia. 4-6)

**Right Wheels**

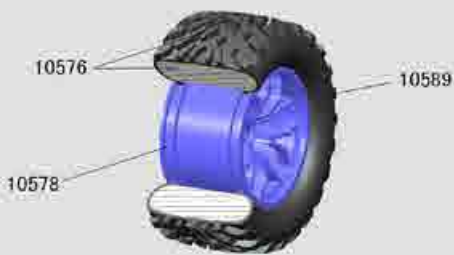

(Dia. 4-4)

**Left Wheels**

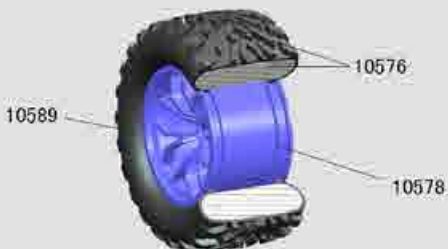

(Dia. 4-5)

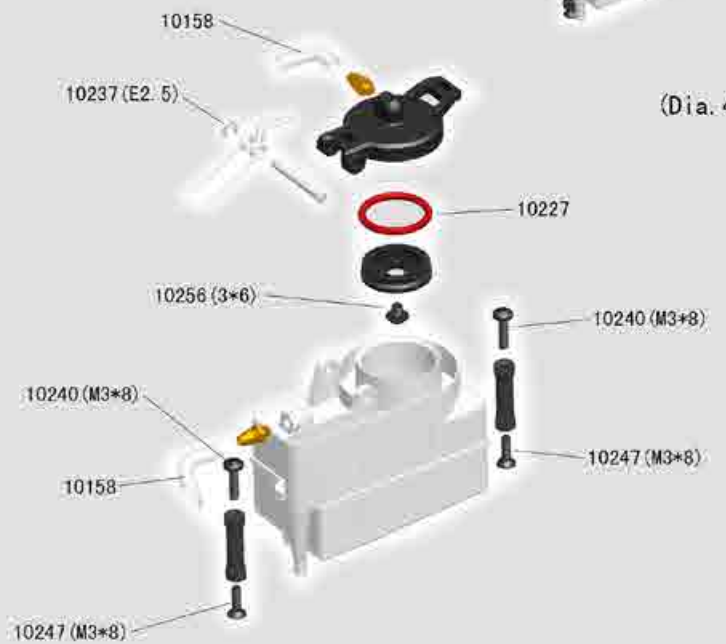

# Assembly Steps :

1. Fasten the fuel tank posts to the chassis, then the fuel tank assembly. (See Dia. 4-6)

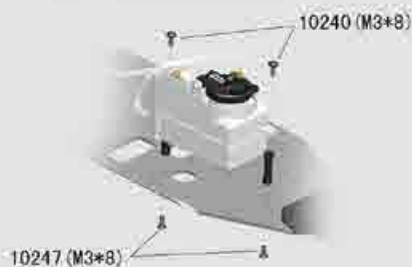

2. Assemble Chassis. (See Dia. 1-3, 4-1, 4-2)

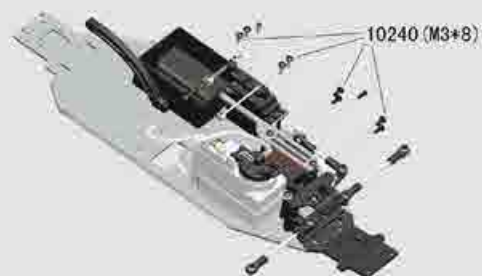

3. Assemble the front assembly to the chassis. (See Dia. 2-1)



4. Assemble the rear assembly to the chassis. (See Dia. 2-4)



5. Tighten the wheels. (See Dia. 4-4 or 4-5)

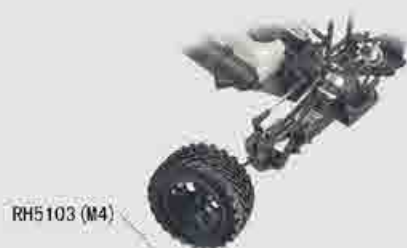

6. Assemble central transmission and rear central drive shaft to the chassis. (See Dia. 3-2 or 3-3)



7. Tighten the engine assembly to the chassis. (See Dia. 3-1)



8. Finally connect battery, receiver and setup the electronics functions, then screw the receiver cover and put on the body. (See Dia. 4-3)

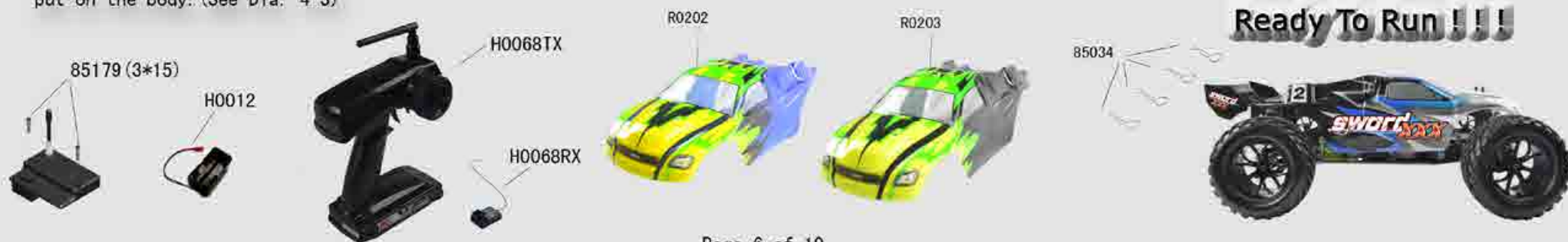

## 1/10 Scale 4WD Electric Powered Car

**RH901 SWORD XXX EBD (Brushed)**

**RH902 SWORD XXX EBL (Brushless)**

### Specifications:

1. Length: 515 mm
2. Width: 325 mm
3. Height: 180 mm
4. Wheelbase: 325 mm
5. Gear Ratio: 11.1:1
6. Tyres:  $\Phi$ 130\*65 mm

*HOT!*



### Standard Equipments:

1. Steering Servo: 3kg/cm
2. Motor: 550 (EBD)  
3650 (EBL)
3. ESC: 60A (EBD)  
300A (EBL)
4. Battery: Ni-MH SC1800mAh 7.2V (EBD)  
Li-Po 3250mAh 7.4V  $\leq$ 25C (EBL)
5. RADIO: 2CH 2.4GHz (EBD)  
2CH 2.4GHz (EBL)

### EBL Brushless System Set



### EBD Brushed System Set





SWORD XXX EBD and EBL are converted from SWORD XXX N1, having same front assembly. Please refer to Dia. 2-1. And the rear assembly is all same as SWORD XXX N1 but without center outdrive cup (see Dia. 6-2)

Attention: SWORD XXX EBD and N1 are only different in ESC, motor battery, charger and radio.

### Central Assembly

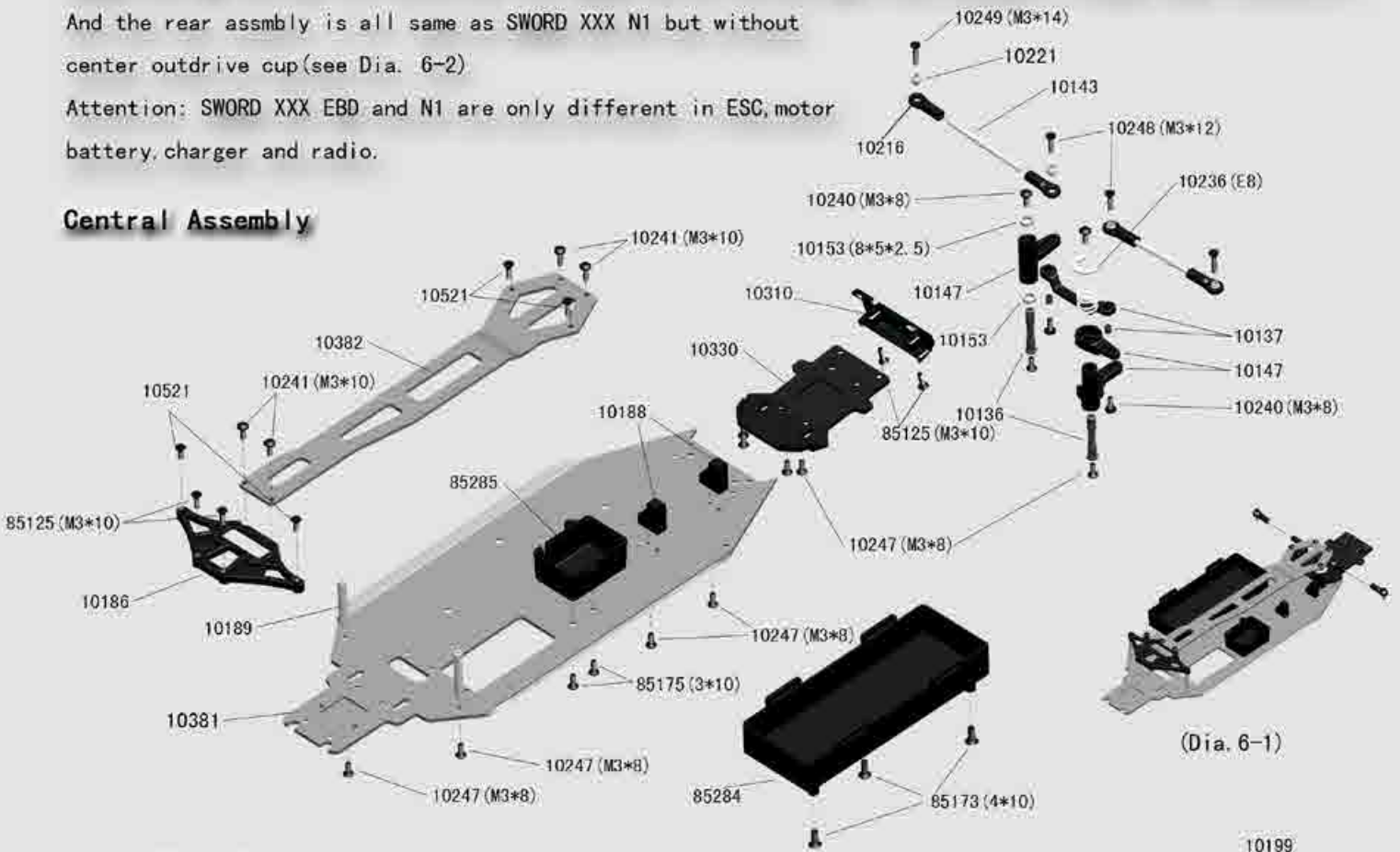

### Rear Assembly



Differential slipper complete is preinstalled in rear assembly, complete.

### Motor Assembly



### Steering Assembly

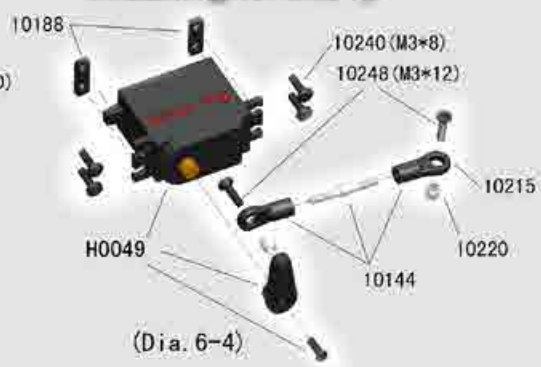

### ESC

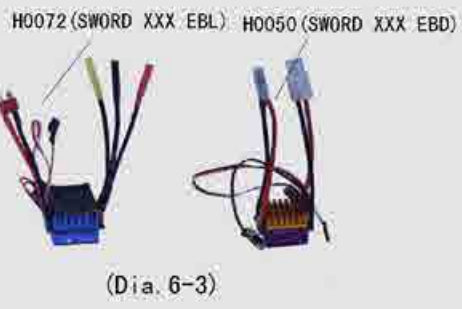

### Receiver



# ASSEMBLY STEPS:

1. Assemble center chassis part.  
(See Dia. 6-1)

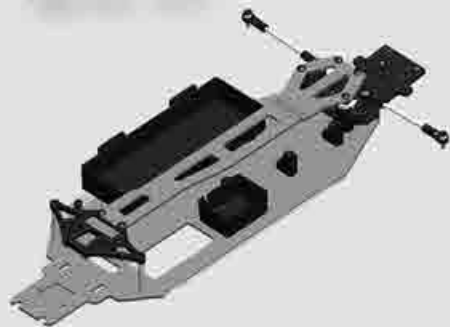

2. Assemble front assembly to chassis front. (See Dia. 2-1)

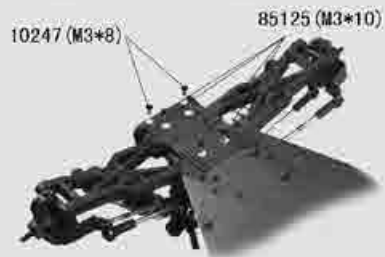

3. Assemble rear assembly to chassis rear part. (See Dia. 2-4)



5. Mount the wheels.  
(See Dia. 4-4, 4-5)



6. Mount the motor assembly and central drive shaft. (See Dia. 6-6)

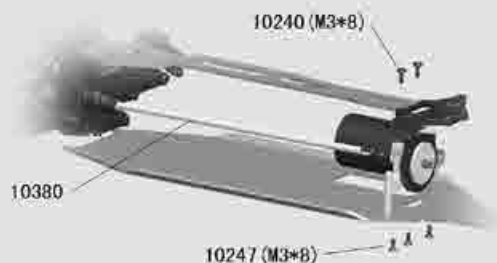

7. Assemble steering servo and linkage. (See Dia. 6-4)



8. Assemble waterproof cover.

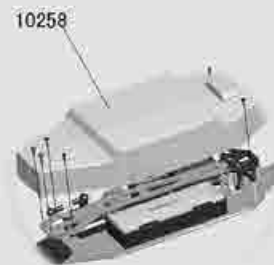

## Ready To Run !!!

9. Assemble ESC, receiver, battery and connect them to setup. (See Dia. 6-3, 6-5)

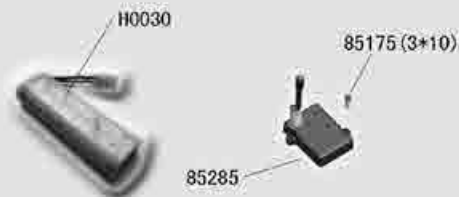

### Brushless System:



### Brushed system:



BODY NUMBER: R0209



BODY NUMBER: R0208



BODY NUMBER: R0202

BODY NUMBER: R0203



## FRONT & REAR SWAY BAR SYSTEM

Sword XXX are just different in electronics system of motor, ESC, battery, charger and radio. And when Sword XXX comes with ST tyres, the trucks will have front & rear sway bar system for better performance.

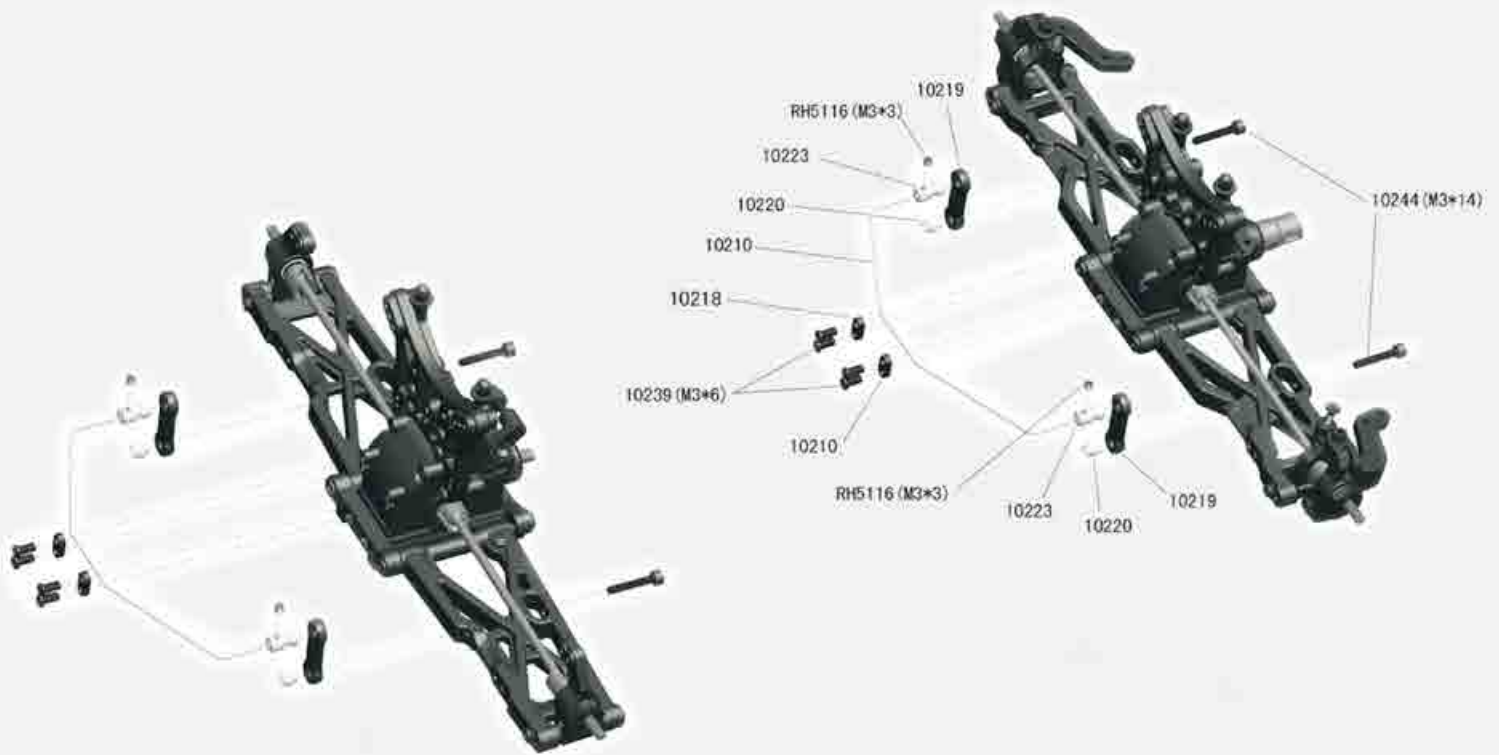













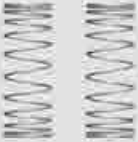
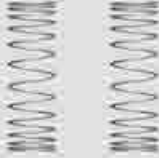





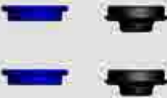
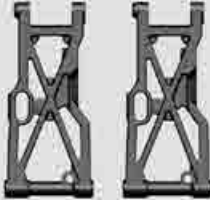
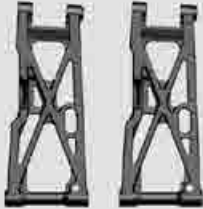

## Wheelie Pack:











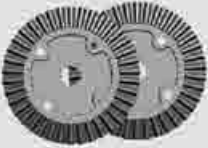











In order to increase the stability operation under top speed for "Super Player", who plays the car with 3S lipo and running cock-up, we design a wheelie system for option.

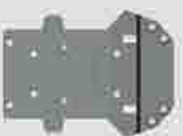

# Part List

<p>10101 - Front Shock Tower 1pc</p>  <p>RH1008/RH1009/RH1018/RH1019</p>	<p>10102 -Rear Shock Tower 1pc</p>  <p>RH1008/RH1009/RH1018/RH1019</p>	<p>10001-Front Shocks 2pc</p>  <p>RH1008/RH1009/RH1018/RH1019</p>	<p>10002 - Rear Shock Tower 2pc</p>  <p>RH1008/RH1009/RH1018/RH1019</p>
<p>10103-Front Shock Spring 2pc</p>  <p>RH1008/RH1009/RH1018/RH1019</p>	<p>10104-Rear Shock Spring 2pc</p>  <p>RH1008/RH1009/RH1018/RH1019</p>	<p>10105-Front Shock Shaft &amp; Piston Set 2sets</p>  <p>RH1008/RH1009/RH1018/RH1019</p>	<p>10106-Rear Shock Shaft &amp; Piston Set 2sets</p>  <p>RH1008/RH1009/RH1018/RH1019</p>
<p>10107-Front Shock Body 2pc</p>  <p>RH1008/RH1009/RH1018/RH1019</p>	<p>10108-Rear Shock body 2pc</p>  <p>RH1008/RH1009/RH1018/RH1019</p>	<p>10109-Shock Upper Cap 2sets</p>  <p>RH1008/RH1009/RH1018/RH1019</p>	<p>10110-Shock Lower Caps 2sets</p>  <p>RH1008/RH1009/RH1018/RH1019</p>
<p>10111-Shock Lower holder &amp; Adjust Ring 2sets</p>  <p>RH1008/RH1009/RH1018/RH1019</p>	<p>10112-Front Lower Susp. Arm 2pc</p>  <p>RH1008/RH1009/RH1018/RH1019</p>	<p>10113-Rear Lower Susp. Arm 2pc</p>  <p>RH1008/RH1009/RH1018/RH1019</p>	<p>10114-Steering Knuckle Arm 1set</p>  <p>RH1008/RH1009/RH1018/RH1019</p>
<p>10115-Uprights 2pc</p>  <p>RH1008/RH1009/RH1018/RH1019</p>	<p>10116-Front CVD 2pc</p>  <p>RH1008/RH1009/RH1018/RH1019</p>	<p>10117-Rear Hub Carrier 2pc</p>  <p>RH1008/RH1009/RH1018/RH1019</p>	<p>10118-Rear Drive Shaft 2pc</p>  <p>RH1008/RH1009/RH1018/RH1019</p>
<p>10119-Rear Dogbones 2pc</p>  <p>RH1008/RH1009/RH1018/RH1019</p>	<p>10123-Gearbox Housing Set 2pcs</p>  <p>RH1008/RH1009/RH1018/RH1019</p>	<p>RH5526-Diff 16T Gear Washer 6pcs</p>  <p>RH1008/RH1009/RH1018/RH1019</p>	<p>10124-Diff.Drive Gear w/pin 2sets</p>  <p>RH1008/RH1009/RH1018/RH1019</p>

















# Part List

<p>10125-Diff Case 2pcs</p>  <p>RH1008/RH1009/RH1018/RH1019</p>	<p>10126-Diff Drive Spur Gear 2pcs</p>  <p>RH1008/RH1009/RH1018/RH1019</p>	<p>10127-Diff Drive Gear 2pcs</p>  <p>RH1008/RH1009/RH1018/RH1019</p>	<p>10128-Diff Bevel Gear S. 4pcs</p>  <p>RH1008/RH1009/RH1018/RH1019</p>
<p>10129-Diff Bevel Gear B. 4pcs</p>  <p>RH1008/RH1009/RH1018/RH1019</p>	<p>10130-Diff Pin 2pcs</p>  <p>RH1008/RH1009/RH1018/RH1019</p>	<p>10131-Washer 6pcs</p>  <p>RH1008/RH1009/RH1018/RH1019</p>	<p>10132-Diff Drive Cup 4pcs</p>  <p>RH1008/RH1009/RH1018/RH1019</p>
<p>10133-Center Coupler 3pcs</p>  <p>RH1008/RH1009/RH1018/RH1019</p>	<p>10379-Body Post 2pcs</p>  <p>RH1008/RH1009/RH1018/RH1019</p>	<p>10135-Servo Saver (GP) 1set</p>  <p>RH1008/RH1009</p>	<p>10136-Servo Saver Post 2pcs</p>  <p>RH1008/RH1009/RH1018/RH1019</p>
<p>10137-Steering Ackerman</p>  <p>RH1008/RH1009/RH1018/RH1019</p>	<p>10141-Front Upper Susp. Arm 2sets</p>  <p>RH1008/RH1009/RH1018/RH1019</p>	<p>10142-Rear Upper Susp. Arm 2sets</p>  <p>RH1008/RH1009/RH1018/RH1019</p>	<p>10143-Steering Arm 2sets</p>  <p>RH1008/RH1009/RH1018/RH1019</p>
<p>10144-Servo Linkage 1pc</p>  <p>RH1008/RH1009/RH1018/RH1019</p>	<p>10145-Wheel Hub 4pcs</p>  <p>RH1008/RH1009/RH1018/RH1019</p>	<p>10146-Antenna Pipe Set 2sets</p>  <p>RH1008/RH1009/RH1018/RH1019</p>	<p>10147-Servo Saver (EP) 1set</p>  <p>RH1018/RH1019</p>
<p>10330-Chassis Front Part 1pc</p>  <p>RH1008/RH1009/RH1018/RH1019</p>	<p>10589 truck wheel complete 2sets</p>  <p>RH1001M/RH1002M/RH1011M/RH1013M</p>	<p>10576 SC truck tyre &amp; insert 2sets</p>  <p>RH1001M/RH1002M/RH1011M/RH1013M</p>	<p>10578 truck rim 2pcs</p>  <p>RH1001M/RH1002M/RH1011M/RH1013M</p>















# Part List

<p>10310-Front Bumper- buggy 1pc</p>  <p>RH1006/RH1007/RH1016/RH1017</p>	<p>10313-Wing Bracket 1set</p>  <p>RH1006/RH1007/RH1016/RH1017</p>	<p>10575-Wing Bracket 2pc</p>  <p>RH1011</p>	<p>10003-Diff Gearbox Set 1set</p>  <p>RH1008/RH1009/RH1018/RH1019</p>
<p>10151-Manifold Gasket 6pc</p>  <p>RH1008/RH1009</p>	<p>10152-Metal Bushing 15*10*4 6pc</p> 	<p>10153-Metal Bushing 8*5*2.5 6pc</p> 	<p>10154-Servo &amp; Upper Plate Mounts 1set</p>  <p>RH1008/RH1009</p>
<p>10156-Upper Plate 1pc</p>  <p>RH1008/RH1009</p>	<p>10157-Upper Steering Plate</p>  <p>RH1008/RH1009</p>	<p>10004-Fuel tank Set 1set</p>  <p>RH1008/RH1009</p>	<p>10158-Fuel Line 2pcs</p>  <p>RH1008/RH1009</p>
<p>10159-Front/Rear Chassis Brace</p>  <p>RH1008/RH1009</p>	<p>10160-Receiver Box 1set</p>  <p>RH1008/RH1009</p>	<p>85026-Switch Cover 2pcs</p>  <p>RH1008/RH1009</p>	<p>10161-Servo Horns</p>  <p>RH1008/RH1009</p>
<p>10162-Chassis Brace mount 1pc</p>  <p>RH1008/RH1009</p>	<p>10163-Stopper 6pcs</p>  <p>RH1008/RH1009</p>	<p>10164-Throttle Linkage 1set</p>  <p>RH1008/RH1009</p>	<p>10165-Central Dongbone F. 1pc</p>  <p>RH1008/RH1009</p>
<p>P0010-GO. 18 engine 1pc P0011-SH. 18 Engine 1pc</p>  <p>RH1008/RH1009</p>	<p>10167-Air filter 1Set</p>  <p>RH1008/RH1009</p>	<p>10168-Tuned Pipe 1Set</p>  <p>RH1008/RH1009</p>	<p>10169-Silicone Coupler 1Set</p>  <p>RH1008/RH1009</p>

# Part List























<p>85195-Zip Tie 6pcs</p>  <p>RH1008/RH1009/RH1018/RH1019</p>	<p>10170-Manifold 1Set</p>  <p>RH1008/RH1009</p>	<p>85035-Flywheel 1pc</p>  <p>RH1008/RH1009</p>	<p>85087-Clutch Nut 2pcs</p>  <p>RH1008/RH1009</p>
<p>85045-Clutch Shoes &amp; Springs</p>  <p>RH1008/RH1009</p>	<p>10171-Clutch Bell (14T) 1pc</p>  <p>RH1008</p>	<p>10172-Clutch Bell (two speed) 1pc</p>  <p>RH1009</p>	<p>10173-Engine mount 2pcs</p>  <p>RH1008/RH1009</p>
<p>10005-Central Transmission Complete 1Set (Single Speed)</p>  <p>RH1008</p>	<p>10174-Central Transmission Bulkheads 2pcs</p>  <p>RH1008/RH1009</p>	<p>10175-Brake Post 1Set</p>  <p>RH1008/RH1009</p>	<p>10176-Brake Set 1set</p>  <p>RH1008/RH1009</p>
<p>10177-Brake Cup 2pcs</p>  <p>RH1008/RH1009</p>	<p>10178-Single Speed Shaft w/pin</p>  <p>RH1008</p>	<p>10179-50T Gear (Single Speed) 1pc</p>  <p>RH1008</p>	<p>10006-Central Transmission Complete 1Set (Two Speed)</p>  <p>RH1009</p>
<p>10180-Two Speed Clutch 1Set</p>  <p>RH1009</p>	<p>10181-Two Speed Shaft 1pc</p>  <p>RH1009</p>	<p>10182-50T Two Speed Gear 1pc</p>  <p>RH1009</p>	<p>10183-45T Two Speed Gear 1pc</p>  <p>RH1009</p>
<p>10360-N1/N2 Chassis Plate 1pc</p>  <p>RH1008/RH1009</p>	<p>10361-Central Dongbone R 1pc</p>  <p>RH1008/RH1009</p>	<p>10185-Battery Cover (EP) 1pc</p>  <p>RH1018/RH1019</p>	<p>10188-Battery Post 2sets</p>  <p>RH1018/RH1019</p>

# Part List



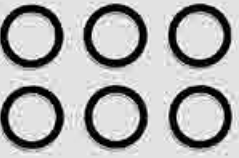





















<p>10189-Post for Rear Spur Gear Cover 2pc</p>  <p>RH1018/RH1019</p>	<p>10190-Motor Mount (EP) 1pc</p>  <p>RH1018/RH1019</p>	<p>10191-Slipper Complete (EP) 1set</p>  <p>RH1018/RH1019</p>	<p>10192-Slipper Pad (EP) 2pc</p>  <p>RH1018/RH1019</p>
<p>10193-Slipper Gasket (EP) 2pc</p>  <p>RH1018/RH1019</p>	<p>10194-65T Spur Gear (EP) 1pc</p>  <p>RH1018/RH1019</p>	<p>10195P-Slipper Shaft (EP) 1pc</p>  <p>RH1018/RH1019</p>	<p>10196-Slipper Spring Bracket (EP) 1pc</p>  <p>RH1018/RH1019</p>
<p>10197-Slipper Spring (EP) 1pc</p>  <p>RH1018/RH1019</p>	<p>10199-Slipper Drive Cup 1pc</p>  <p>RH1018/RH1019</p>	<p>10200-BEARING BRACKET (EP) 1pc</p>  <p>RH1018/RH1019</p>	<p>10201-Pinion Gear 17T (EP) 1pc</p>  <p>RH1018/RH1019</p>
<p>10210-Sway Bar 2Sets</p>  <p>RH1018/RH1019</p>	<p>10380-Center Drive Shaft (EP) 1pc</p>  <p>RH1018/RH1019</p>	<p>10381-EBD/EBL chassis plate 1pc</p>  <p>RH1018/RH1019</p>	<p>10382-EBD/EBL upper plate 1pc</p>  <p>RH1018/RH1019</p>
<p>85034-Body Clip (Medium Size) 6pcs</p> 	<p>85029-Body Clip (Small Size) 6pcs</p> 	<p>10214-Shock Ball End 6pcs</p> 	<p>10215-Servo Link Ball End 6pcs</p> 

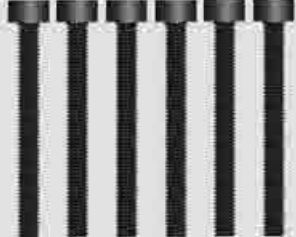

# Part List

<p>10216-Steering Linkage Ball End 6pcs</p> 	<p>10217-Rear Upper Linkage Ball End 6pcs</p> 	<p>10218-Sway Bar Fix Plate 6pcs</p> 	<p>10219-Sway Bar Holders 6pcs</p> 
<p>10220-Ball A 6pcs</p> 	<p>10221-Ball B 6pcs</p> 	<p>10222-Ball C 6pcs</p> 	<p>10223-Ball D 6pcs</p> 
<p>10224-Shock O-ring (Lower) 6pcs</p> 	<p>10225-Diff O-ring Seal 6pcs</p> 	<p>10226-Shock O-ring (upper) 6pcs</p> 	<p>10227-Tuned Pipe Seal &amp; Fuel Tank Seal 1set</p> 
<p>10228-Pin <math>\phi</math>2*10 6pcs</p> 	<p>10229-Pin <math>\phi</math>2*11 6pcs</p> 	<p>10230-Hinge Pins (long &amp; short) 2sets</p> 	<p>10231-One Way Bearing 3pcs</p> 
<p>10232-Ball Bearing 15*10*4 6pcs</p> 	<p>10233-Ball Bearing 10*5*4 6pcs</p> 	<p>10234-Metal Bushing 10*5*4 6pcs</p> 	<p>10235-Ball Bearing 8*5*2.5 6pcs</p> 
<p>10236-E clip-8mm 4pc</p> 	<p>RH5190-E clip-4mm 6pc</p> 	<p>10237-E clip-2.5mm 6pc</p> 	<p>RH5102-Nylon Lock Nut M3 6pc</p> 

# Part List

<p>RH5103-Nylon Lock Nut-M4 6pc</p> 	<p>85148-Round Head Self Tapping Hex Screw 2*6 4pcs</p> 	<p>10238-Round Head Self Tapping Hex Screw 2*10 6pc</p> 	<p>85179-Round Head Self Tapping Hex Screw 3*15 8pc</p> 
<p>10239-Round Head Self Tapping Hex Screw M3*6 6pc</p> 	<p>10240-Button Head Hex Screw M3*8 6pc</p> 	<p>10241-Button Head Hex Screw M3*10 6pc</p> 	<p>85184-Button Head Hex Screw M3*12 6pc</p> 
<p>10242-Button Head Hex Screw M3*14 6pc</p> 	<p>85144-Ring Self Tapping Screw 3*4 4pc 10256-Ring Self Tapping Screw 3*6 6pc</p> 	<p>RH5116-Set Screw M3*3 6pc</p> 	<p>RH5117-Set Screw M4*4 6pc</p> 
<p>RH5118-Button Head Hex Screw M4*10 6pc</p> 	<p>RH5562-Cap Head Hex Screw M3*8 6pc</p> 	<p>10243-Cap Head Hex Screw M3*10 6pc</p> 	<p>85182-Cap Head Hex Screw M3*10 6pc</p> 
<p>10244-Cap Head Hex Screw M3*14 6pc</p> 	<p>85119-Cap Head Hex Screw M3*16 6pc</p> 	<p>10245-Cap Head Hex Screw M3*18 6pc</p> 	<p>85185-Cap Head Hex Screw M3*25 6pc</p> 
<p>10246-Cap Head Hex Screw M3*28 6pc</p> 	<p>10247-Flat Head Hex M3*8 6pc</p> 	<p>85125-Flat Head Hex Screw M3*10 8pc</p> 	<p>85175-Flat Head Hex Screw 3*10 8pc</p> 

# Part List

<p>10248-Flat Head Hex Screw M3*12 6p</p> 	<p>10249-Flat Head Hex Screw M3*14 6p</p> 	<p>85127-Flat Head Hex Screw M3*18 3p</p> 	<p>10250-Flat Head Hex Screw M3*20 6p</p> 
<p>10251-Flat Head Hex Screw M3*36 6p</p> 	<p>85173-Flat Head Hex Screw M4*10 6p</p> 	<p>H0068 - 2.4GHz Transmitter 1pc</p> 	
<p>H0072 - Brushless ESC 1pc</p> 	<p>H0050-400A ESC 1pc</p> 	<p>H0028 - 3650 Brushless Motor 1pc</p> 	<p>H0029 - 550 Brushed Motor 1pc</p> 
<p>H0030 - Ni-MH 7.2V 1800mAh 1pc H0031 - Ni-MH 7.2V 3000mAh 1pc</p> 	<p>H0012 - Battery Case 1pc</p> 	<p>H0049 - 3kg/cm Servo 1pc</p> 	<p>85274-Li-Po-3250mAh 7.4V 1pc</p> 
<p>10253 - 1/10 Charger CE 1pc 10254 - 1/10 Charger UL 1pc 10255 - 1/10 Charger BS 1pc</p> 	<p>RH5189 - Receiver Switch 1pc</p> 	<p>85284-Battery case 1pc</p> 	<p>85285-RX case 1set</p> 
<p>R0202-Printed SC truck body 1pc</p> 	<p>R0203-Printed SC truck body 1pc</p> 	<p>10258-waterproof cover 1pc</p> 	<p>10629-Buggy Tail Wing 1pc</p> 

# Upgrade Parts List

<p>10902 - Front Shock Plate (Carbon) 1Set</p>  <p>RH1009/RH1018/RH1019</p>	<p>10903 - Rear Shock Plate (Carbon) 1Set</p>  <p>RH1009/RH1018/RH1019</p>	<p>10906-Body Post (AL) 2pc</p>  <p>RH1019</p>	<p>10907-Front Shocks (AL) 2pc</p>  <p>RH1009/RH1018/RH1019</p>
<p>10908-Rear Shocks (AL) 2pc</p>  <p>RH1009/RH1018/RH1019</p>	<p>10909 - Front Lower Susp. Arm (AL) 2pc</p>  <p>RH1009/RH1018/RH1019</p>	<p>10910 -Rear Lower Susp. Arm (AL) 2pc</p>  <p>RH1009/RH1018/RH1019</p>	<p>10911 - Steering Ackerman (AL) 1pc</p>  <p>RH1009/RH1018/RH1019</p>
<p>10912 - Front Susp. Holders (AL) 1Set</p>  <p>RH1009/RH1018/RH1019</p>	<p>10913 - Front &amp; Rear Brace(AL) (AL) 1Set</p>  <p>RH1009</p>	<p>10914 - Rear Susp Holders (AL) 1Set</p>  <p>RH1009/RH1018/RH1019</p>	<p>10915 - Rear Hub Carrier (AL) 2pc</p>  <p>RH1009/RH1018/RH1019</p>
<p>10916-Front Top Plate (Carbon) 1pc</p>  <p>RH1009</p>	<p>10917 - Steering Knuckle Arm (AL) 2Set</p>  <p>RH1009/RH1018/RH1019</p>	<p>10918 - Wheel Hub (AL) 4pc</p>  <p>RH1009/RH1018/RH1019</p>	<p>10919 - Upper Plate(AL) 1pc</p>  <p>RH1009</p>
<p>10920 - Tuned Pipe(AL) 1Set</p>  <p>RH1009</p>	<p>10921 - Chassis Brace mount (AL) 1pc</p>  <p>RH1009</p>	<p>85265 - Heatsink 1pc</p>  <p>RH1019</p>	<p>10923 - Alum Steering Arm 2pc</p>  <p>RH1009/RH1018/RH1019</p>
<p>10924 - Alum Knuckle Arm 2pc</p>  <p>RH1009/RH1018/RH1019</p>	<p>10925 - Alum Knuckle Arm 1set</p>  <p>RH1009/RH1018/RH1019</p>	<p>10932 - Alum Chassis Front Part 1pc</p>  <p>RH1009/RH1018/RH1019</p>	