

# 1/10th 4WD Electric Power R/C MONSTER TRUCK



































## Specifications:

LENGTH	WIDTH	HEIGHT	WHEEL BASE	GROUND CLEARANCE	DIAMETER OF WHEEL	WIDTH OF WHEEL	GEAR RATIO	SERVO	WEIGHT
485mm	315mm	145mm	280mm	68mm	125mm	65mm	1:9.8	6kg	2500g



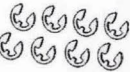















## Spare Part

70101-Chassis 	70102-Battery/Receiver Case 	70103-Motor Cover 	70104-Front Bumper 	70105-LED Light Clip (Optional) 
70106-Wheelie Wheel Mount 	70107-Steering Sway Arm Assembly 	70108-Wheelie Wheel Mount 	70135-Wheelie Wheel 	70136-Steering Link 62mm 
70143-Rear Upper Link 	70137-Servo Link 	70138-Wheel Hex 	70114-Solid Plate 	70115-Rear Chassis Plate 
70139-Front Chassis Plate 	70140-Front Upper Arm Holder 	70118-ESC Mount 	70119-Wheel Rim 	70120-Tire+Inside Sponge L/R 
70121-Wheel Complete L/R 	70122-Motor Mount 	70123-Servo Saver Assembly 	70124-Steering Post 	70125-Drive Gear 
70126-Universal Drive Joint 	70128-Battery Strap 250mm 	73303-Front/Rear Lower Arm 	73304-Front/Rear Upper Arm 	08012-Shock Tower 
08007-Body Post 	73305-Steering Hub (Left/Right) 	06045-Front Gear Box Housing 	03013-Radio Tray Holder 	02039-Differential Box (With 2Rings&Steel Washers) 



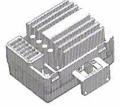



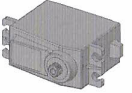







## Spare Part

02024-Diff Gear Complete 	02030-Drive Gear 	08074-Crown Gear(38T) (Coper infiltration) 	02066-Diff.Pinions+Bevel Gears+Pin 	11184-Diff.Main Gear Metal(64T) 
11200-Motor Gear Metal (19T) 	02032-Wheel Axle 	02016-Universal Joint Cup B+Grub Screw 	08001-Shock Absorber 	60298-Servo Arm 
02153-Ball Head Nut 8P 	14559-Ball Bearing $\Phi 8 * \Phi 5 * 2.5$ 	02138-Ball Bearing $\Phi 15 * \Phi 10 * 4$ 	02139-Ball Bearing $\Phi 10 * \Phi 5 * 4$ 	02164-Ball Head Cap 8P 
02079-Oil Bearing $\Phi 15 * \Phi 10 * 4$ 	02080-Oil Bearing $\Phi 5 * \Phi 10 * 4$ 	50078-Servo Washers $\Phi 3 * 8 * 0.8mm$ 	02173-Suspension Arm 	04003-Centre Dogbone 
02036-3*44mm Front Suspension Arm Pin A 	08069-Front Lower Suspension Arm Round Pin B 3*43mm 	02152-M5 Ball Head Screw 8P 	60240-Ball Head Screws 5.8mm 	06007-Shock Ball Head 
02102-Nylon Nut M3 	02099-Grub Hex. Screw M4*4 	70129-Flange M4 Lock Nut 	60242-Steering Shaft Bush 	70127-E-Clip ( $\Phi 2.5$ ) 
50043-E-Clips $\Phi 4mm$ 	02053-Body Clip 	08021-Shock Ball Head 1 	10390-Ball Head A 	08027-Pin 2*10mm 

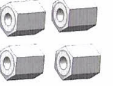
## Spare Part

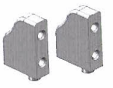
<p>85845-Cap Head Hex Self-Tapping Screw 3*8 4P</p> 	<p>50100-Cap Head Hex Machine Screw 3*10 8P</p> 	<p>50101-Cap Head Hex Machine Screw 3*12 12P</p> 	<p>85843-Cap Head Hex Self-Tapping Screw 3*12 4P</p> 	<p>85846-Cap Head Hex Self-Tapping Screw 3*14 4P</p> 
<p>70133-Flat Head Hex Machine Screw 3*16 8P</p> 	<p>70134-Flat Head Hex Machine Screw 3*18 8P</p> 	<p>02086-Round Head Self-Tapping Screw 2*10 10P</p> 	<p>70130 - Countersunk Screw 3*6</p> 	<p>02093-M3*10 Column Head Hex. Screw 10P</p> 
<p>85825-Flat Head Hex Machine Screw 3*10 4P</p> 	<p>70132-Flat Head Hex Self-Tapping Screw 3*8 10P</p> 	<p>85837-Flat Head Hex Self-Tapping Screw 3*10 12P</p> 	<p>70131 - Column Head Machine Screw 3*45</p> 	<p>03200-Battery Ni-MH (7.2V 2000mAh)</p> 
<p>03064- ESC (40A)</p> 	<p>28446-8020 - Motor (Re550)</p> 	<p>03205-Lipo Battery 7.4V 3500mAh (Optional)</p> 	<p>37022 - Brushles ESC (Optional 60A)</p> 	<p>03302-Brushless Motor 3300KV (Optional)</p> 
<p>SP6002- Servo 6kg</p> 				

## Upgradable Optionals

<p>108837 -Aluminum Body Post -4P (truck)</p> 	<p>188818 -Aluminum Front/Rear Upper Arm-2p (truck)</p> 	<p>188819 -Aluminum Front/Rear Lower Arm-2p (truck)</p> 	<p>122075 -Aluminum Gear Box</p> 	<p>188004 -Aluminum Shock Absorber- 2P (truck)</p> 
<p>166617 -Aluminum Front/Rear Servo Link-2P (buggy/Sc/Truck)</p> 	<p>122211 -Aluminum Steering Hub - 2P (on - road/truck)</p> 	<p>188822 -Aluminum Shock Tower-1P (truck)</p> 	<p>701001 - Steering Sway Arm Assembly</p> 	<p>701002 - Wheel Hex</p> 
<p>701003 - Front Upper Arm Holder</p> 	<p>701004 -Wheelie Wheel Mount</p> 	<p>701005 - Radio Tray Holder</p> 	<p>701006 - Solid Plate</p> 	<p>701007 -ESC Mount</p> 
<p>102048-Aluminum Nut M3</p> 	<p>102049-Aluminum Nut M4</p> 			

### 1. Differential Assembly

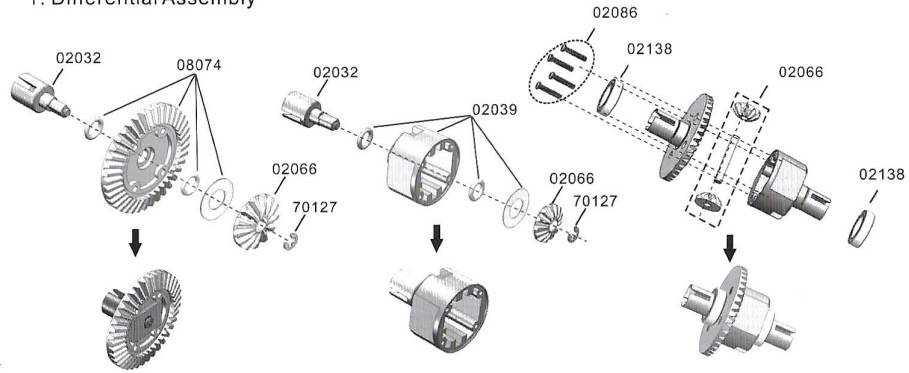

### 2. Front Gear Box Assembly

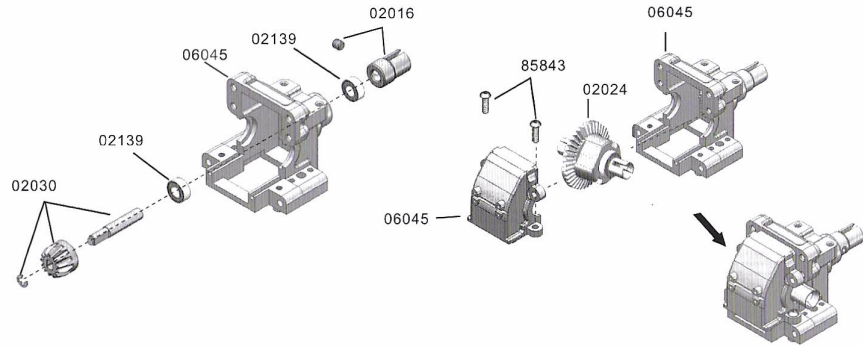

### 3. Rear Gear Box Assembly

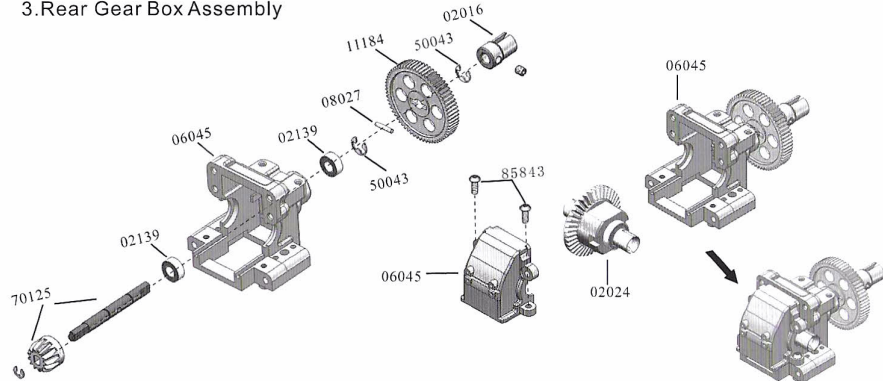

### 4. Shock Tower

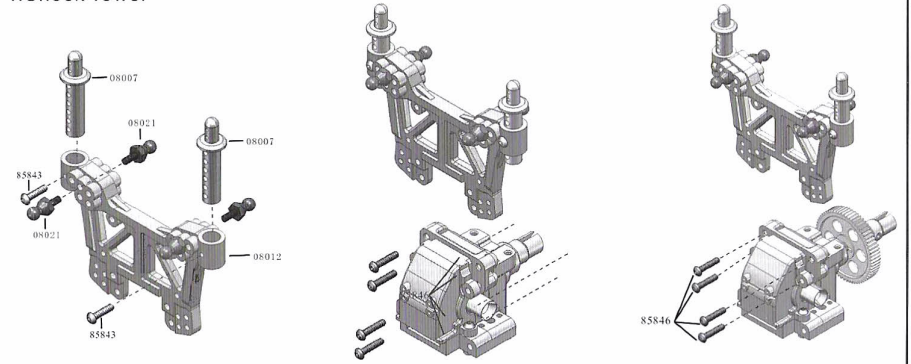

### 5. Suspension

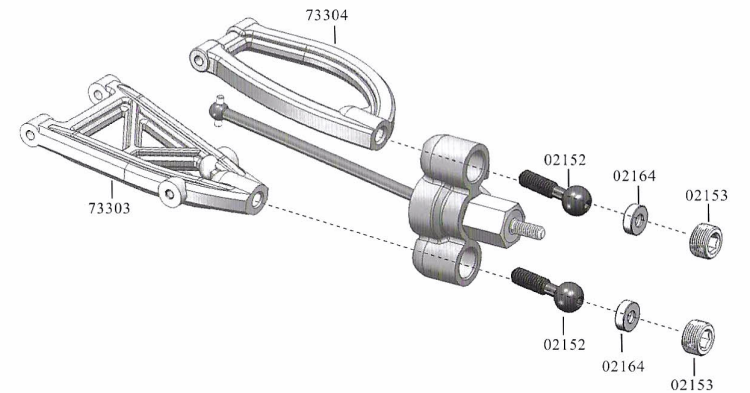
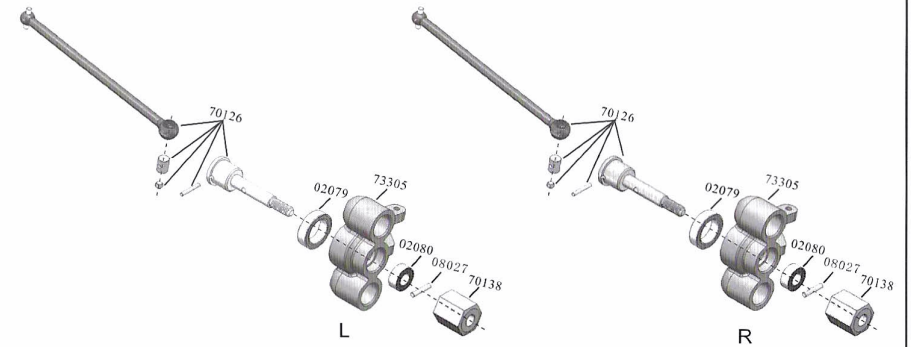



### 9. Wheel Lie Mounting

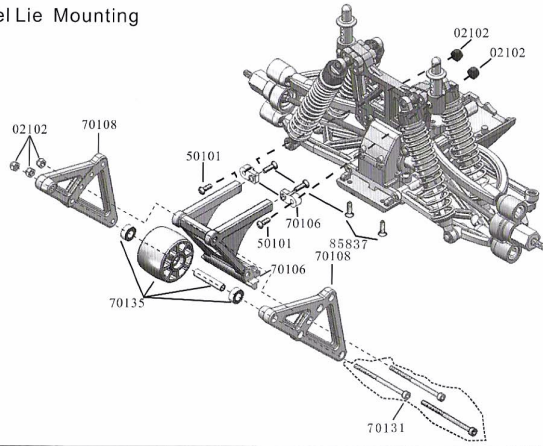

### 11. Rear Arm Assembly

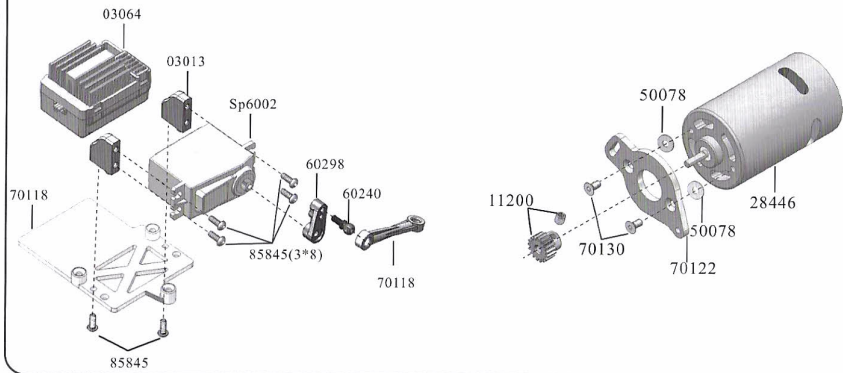
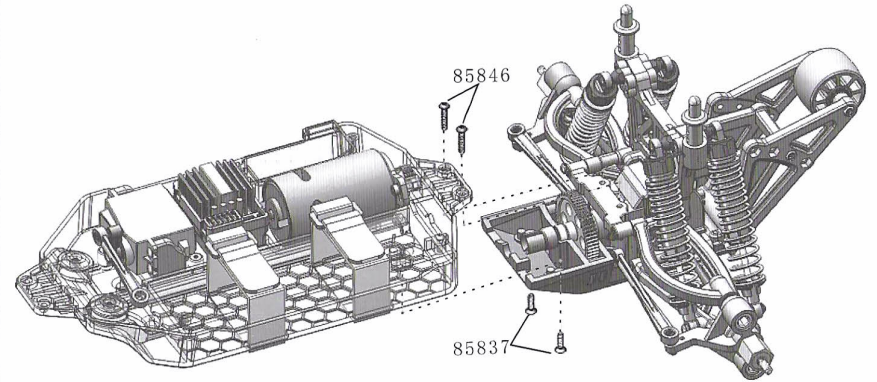

### 10. Motor

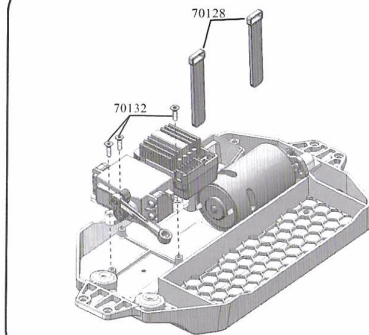
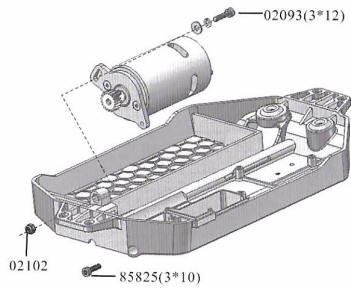

### 12. Lock The Electric Parts

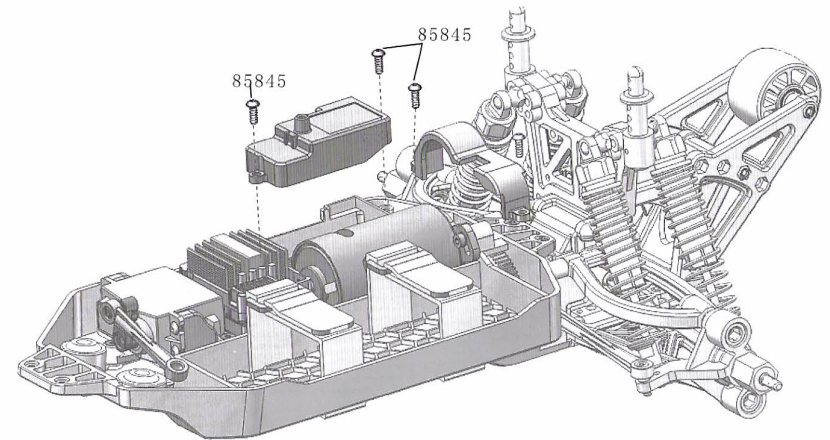

### 13. Front Arm Assembly

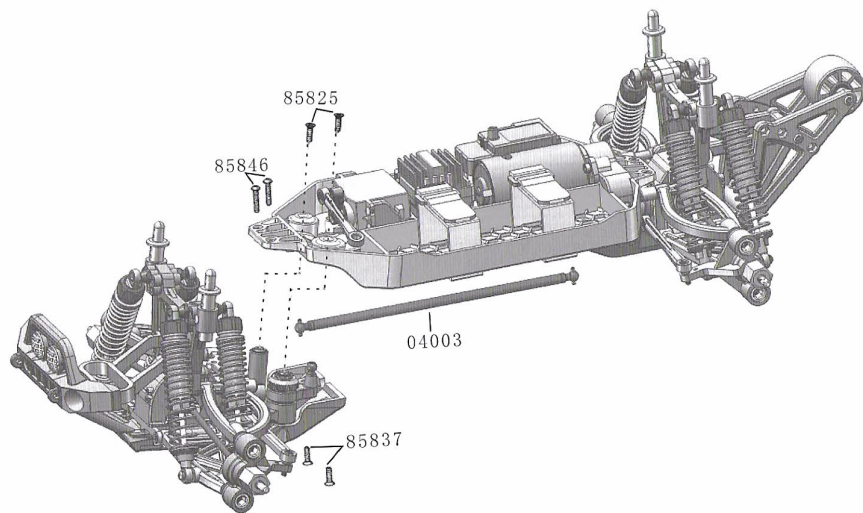

### 14. Wheel Mounting

