

# Smart Double Power Point

## User manual

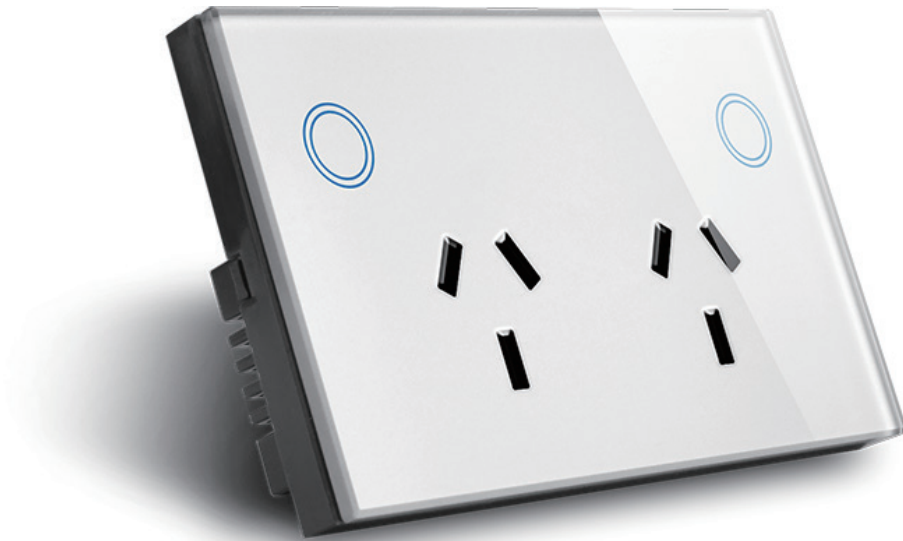

## Features

1. High quality tempered glass panel design,never fade.
2. With blue and red LED indicator,very distinguished.
3. Easy to install,replace the old switch directly.
4. Power metering function.
5. Check socket status,and remember last status.
6. Support Amazon Alexa and Google Assistant ,etc.

# Installation

1. Open the front cover by a small flat screwdriver

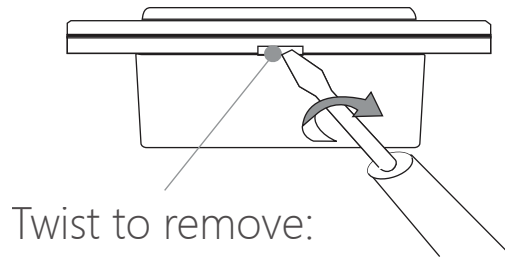

2. Wiring

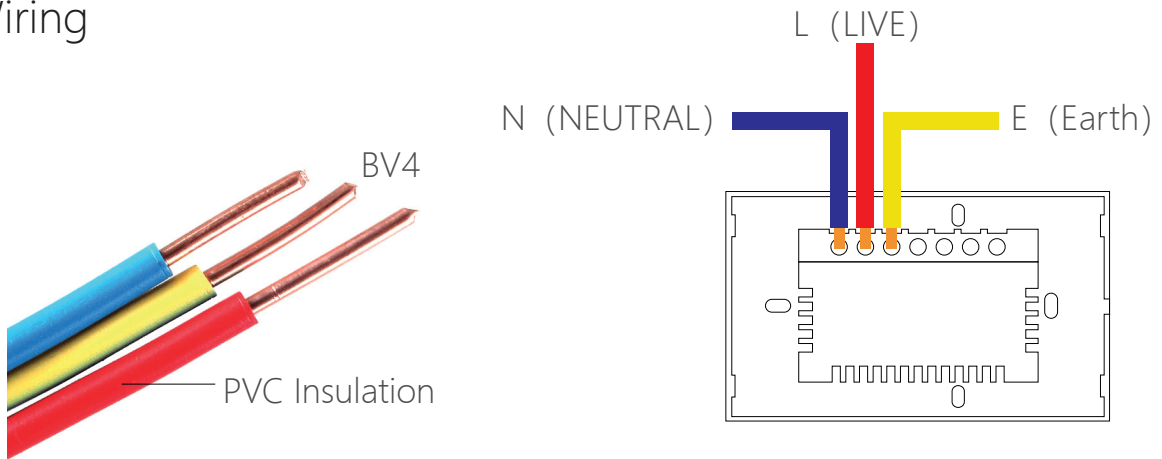

3. Fix screws

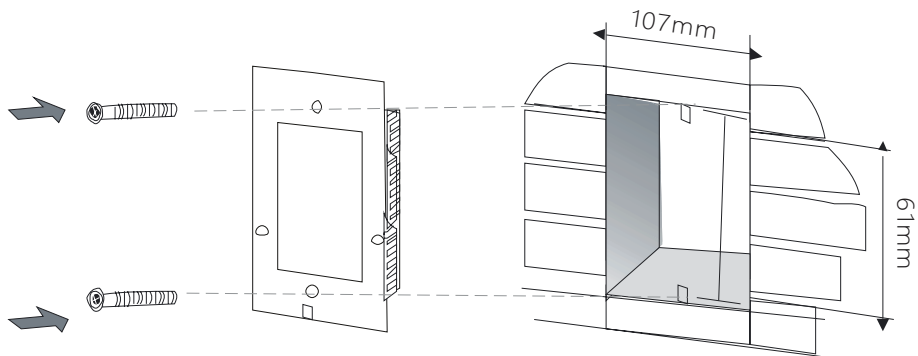

4. Cover the panel and connect the power.

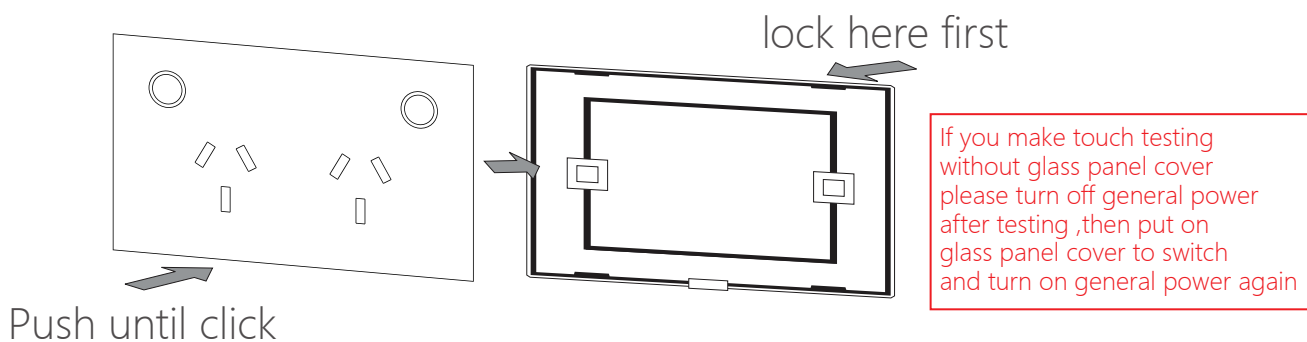

## Connect to your Wifi

Ensure your mobile phone is connected to your 2.4GHz Wifi network. Your mobile phone and your smart switch needs to be within good signal strength range of your Wifi router.(Refer to your router specifications for max range.)

## Download&Register the APP

Please download the free app from the App store or Google Play store, or scan the QR code below.

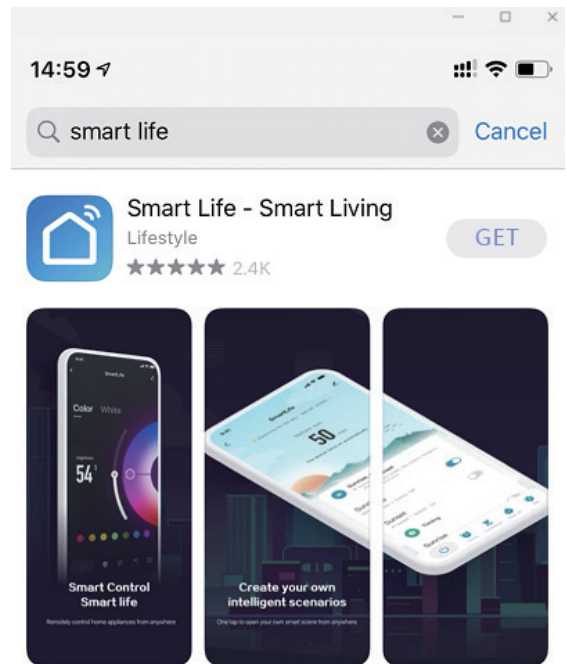

Open the Smart Life app. For new users,register a new account or if existing user.login with your user name and password.

## Add your Smart Switch to your App

- 1.Arrange installation of your smart switch by a licensed electrical contractor(refer installation instructions at start of this manual)
- 2.Once safely wired and powered on ,then hold the button for 5 seconds until the buttons start to blink rapidly.

3. Open "Smart Life", Click top right-hand "+"  
Then choose "Electricain" -- "Switch(Wi-Fi)"

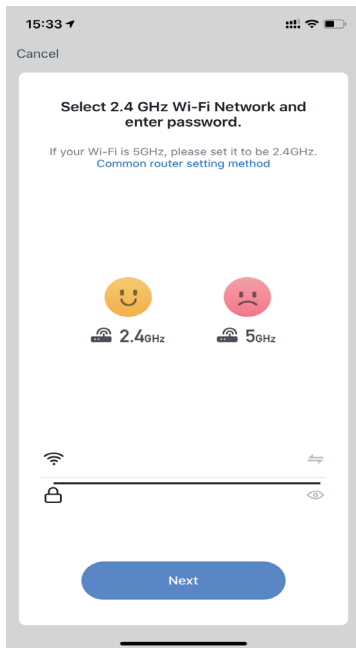

Enter your Wifi password

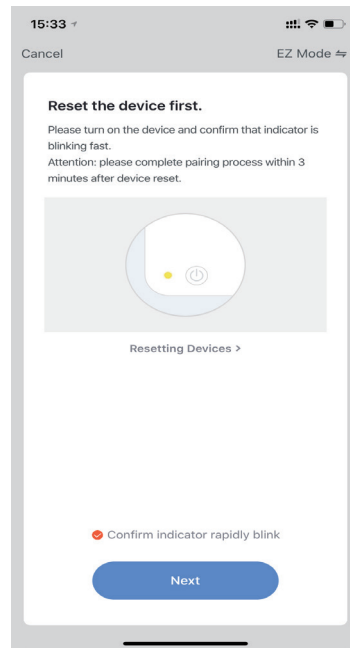

Connection will now begin

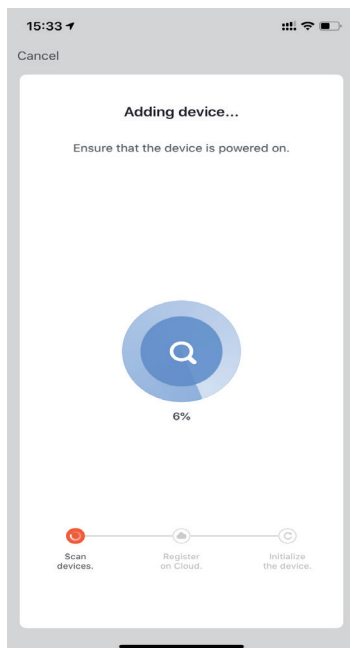

Adding device...

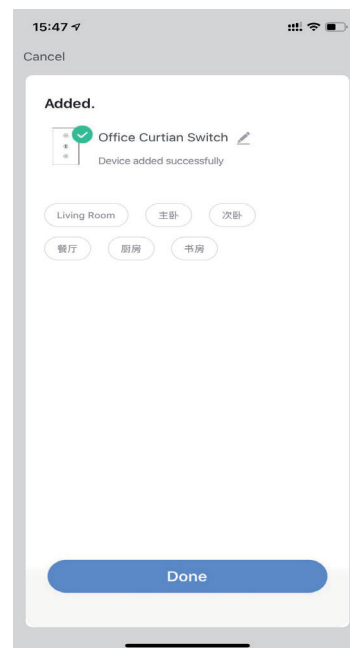

Finished

Using your smart life app you can turn this device ON/OFF. Each touch switch can be controlled individually. See over for voice control

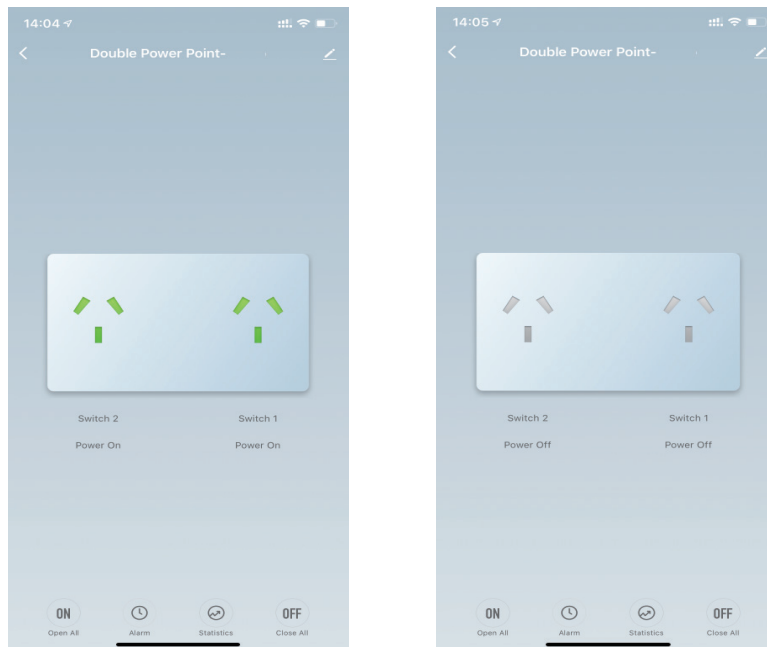

## Other functions

### Timer&Schedule function

Click to set ON/OFF time.

### Manual override

The touch switch can be used to manually turn ON/OFF power to the load/s

## Power metering function

### Electric stats

This allows you to monitor the power usage of connected loads (current,power,voltage and kWh).

The values show are the total of all gangs per wall plate.These values are for reference only.

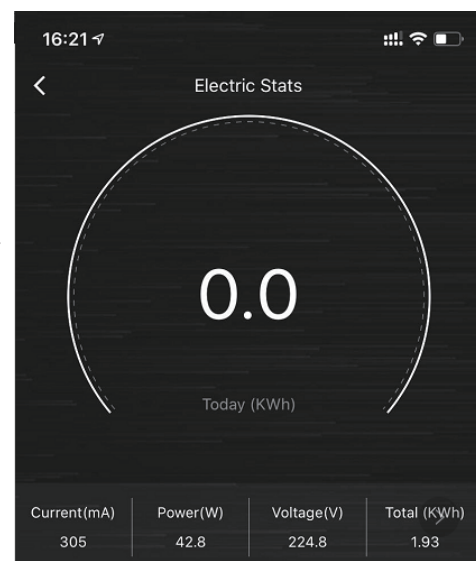

# Voice control

To integrate with Amazon Alexa or Google Assistant device  
Open the smart life app press  
'profile'then 'Settings' then integration'

Click on Amazon Alexa or Google Assistant and follow the setps.

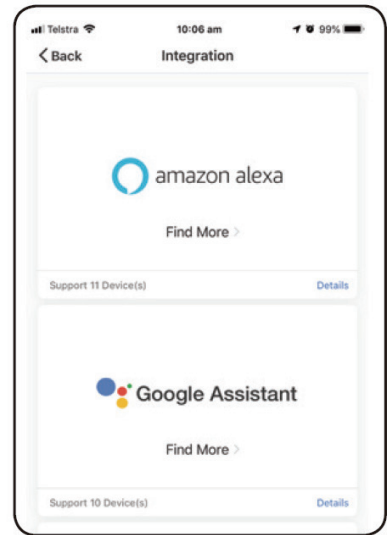

# Specification

Dimension: 120\*72\*42MM

Voltage: 110-240V AC/50~60Hz

Operation current:10A

Wifi Standard:IEEE802.11b/g/n

# Warning

- 1.To prevent injury,this apparatus must be installed by a Licensed Electrical Contractor.
2. For indoor used only.
- 3.Please make sure the smart switch is not overloaded.  
Working power cannot be higher than the rated power (10A Socket)

# Warranty

This warranty covers defects in manufacturing that arise from the correct use of the device. It is limited to defects in materials or workmanship and does not cover damage caused by abuse, misuse, unauthorised modification, power surge damage or extreme heat or cold or corrosive environments. The warranty also does not cover the normal wear and tear on covers, cases, housings, connectors and accessories.

The warranty does not apply to any product with missing, altered or defaced serial numbers. Your products come with a 12 month manufacturer's warranty as standard.